

Manual

mz-12 PRO

12 channel HoTT 2,4 GHz transmitter

No. S1002.PRO

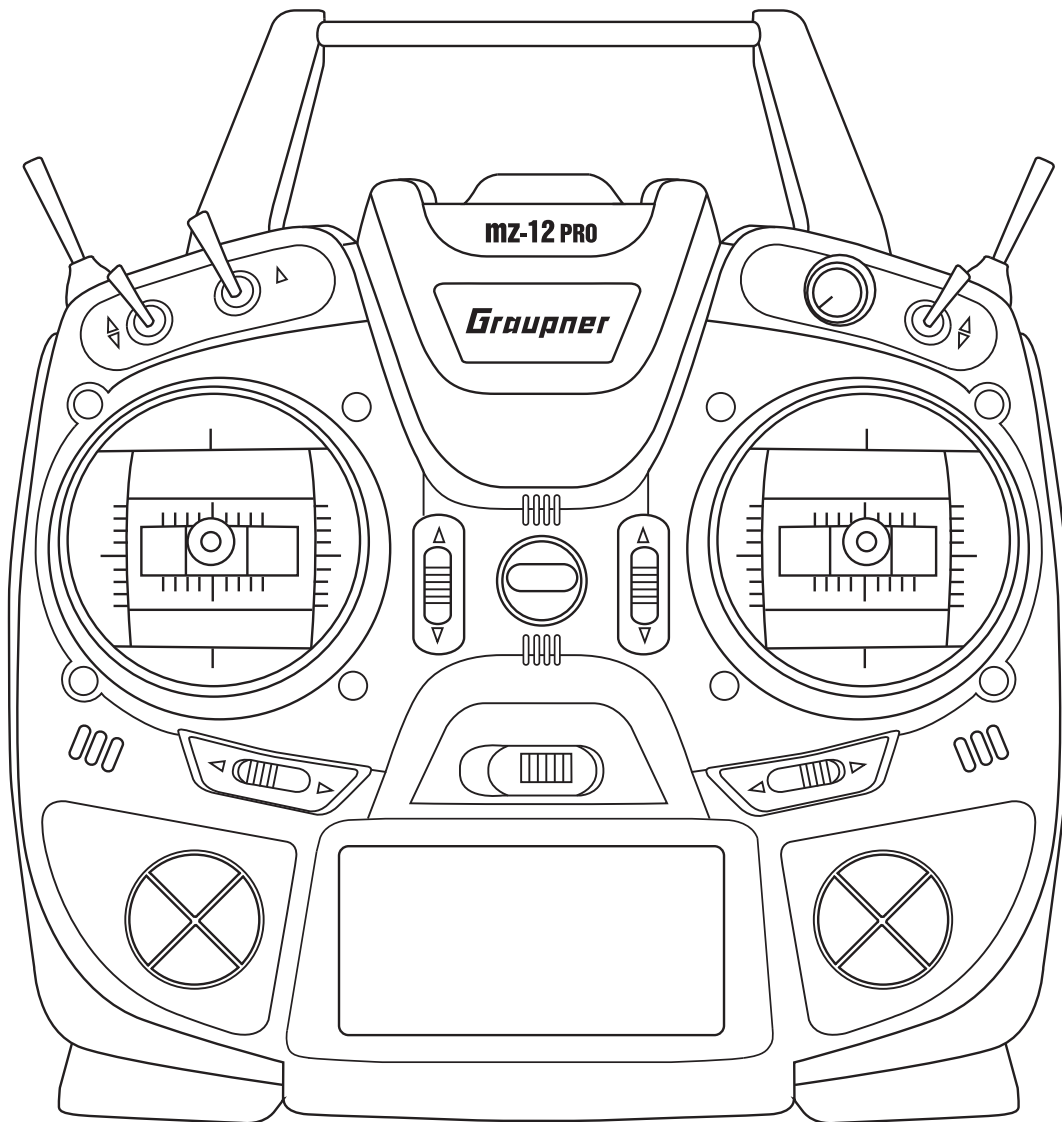

CE Part 2

1
Graupner

Index

Introduction	9
Service center	9
Intended use	10
Target group.....	10
Package content	10
Symbol description	11
Safety notes.....	11
Foreword	12
Short-Cuts.....	13
CLEAR	13
"Servo display"	13
"Telemetry" menu.....	13
Graphic display of "telemetry" data	13
"HIDDEN MODE"	13
Key lock	13
Definition of terms	14
Control function.....	14
Controls.....	14
Control channel.....	14
Mixer	14
Switch.....	14
Meaning of the warnings	15
Receiver assignment	16
Fixed-wing models	16
Motor-powered airplanes and glider models	16
Delta/flying-wing models with and without motor.....	17
Helicopter models.....	18
Land and water models	19
Copter	19
Control, switch and control switch assignment	20
Controls assignment	20
Switch assignment	20
Deleting switches	20
Control switch	20
Digital trim / Throttle switch-off trim.....	21
Menu description	
Model memory	22
Model selection	22
Model name.....	23

Delete model	23
Copy Mod=>Mod.....	24
Model types/Phase.....	25
Model type (Air, land and water models).....	25
Motor on CH1	25
Throttle Cut.....	26
Tail plane	27
Ailerons/Flaps	28
Model type (helicopter).....	29
Swashplate type.....	29
Throttle Cut.....	30
Rotor direction	32
Pitch min	32
Autorotation.....	32
Phase setting (Air, land and water models).....	33
Phase setting (helicopter).....	34
Phase trim (airplane)	35
Motor OFF+timer.....	35
Thr.HOLD	35
Min.thr. min	37
Timers	37
Race Timer	38
Servo/channel setting.....	39
Column 1	39
Column 2 "Rev"	39
Column 3 "Centre"	39
Column 4 "- Trv +"	40
Control setting.....	41
Column "Control"	41
Column "- Trv +"	42
Helicopter specific settings.....	42
Throttle	42
Gyro.....	42
Lim.....	43
Dual Rate / Expo.....	43
Transmitter setting	45
System menu- Control mode.....	45
Timers	47
Receiver output	47
Bound receiver (binding)	48
Range test	49
RF module	50
Binding type	51

Throttle curve.....	52
Wing Mix.....	53
Aile diff.	53
FLAP diff.	53
AI => RU	54
AI => FL.....	54
C1 => EL.....	54
C1 => FL.....	55
C1 => AI	55
EL => FL	55
EL => AI.....	55
FL => EL	55
FL => AI.....	56
Differentiation reduction	56
Helicopter mixer	57
Pitch	57
C1 => Thr	58
C1 => Tail.....	58
Tail => Thr.....	59
Roll => Thr / Nick => Thr	59
Gyro suppression	59
Gyro.....	60
SP limit	60
Speed controller on CH8.....	60
Speed controller setting	61
Phase.....	61
Phase setting (copter).....	61
Phase trim (copter).....	62
Free mixers	63
General settings.....	66
Battery alarm threshold.....	67
Keys reaction.....	67
Contrast.....	67
Display light.....	67
RF Region	67
Voice volume.....	67
Signal volume.....	67
Rear socket.....	68
DATA select.....	68
DSC socket.....	68
USB joystick.....	68
Fail-Safe.....	69
Teacher/Pupil	70

Preparing for training mode	70
Trainer mode with DSC cable	72
Wireless HoTT system.....	72
Announce	73
Info display	74
RFID.....	74
Firmware version	74
Default setting.....	75
Telemetry	76
SETTING & DATA VIEW	77
RX DATAVIEW	77
RX SERVO.....	80
RX FAIL SAFE.....	82
RX FREE MIXER.....	87
RX CURVE	89
RX SERVO TEST	91
SETTINGS & DISPLAYS sensor(s)	96
SENSOR	97
Display of RF status	97
SELECT ANNOUNCE	98
REPEAT	98
NEXT ANNOUNCE	98
VARIO	99
Transmitter	99
RECEIVER.....	99
"Sensors"	99
Telemetry data display.....	100
RECEIVER.....	101
General module	102
Microcopter display	103
Battery and consumption display.....	103
SENSOR 1 and SENSOR 2	103
RPM sensor	103
Vario	104
Speed display	104
Air pressure display.....	104
"lowest cell"	104
ELECTRIC AIR MODULE	104
Microcopter display	105
BAT	106
SENSOR 1 and SENSOR 2	106
Vario	106
Speed display	106
"lowest cell"	106

VARIO	107
Microcopter display	107
Vario	108
Text displays	108
GPS	108
Microcopter display	109
GPS	109
Vario	109
Speed display	110
AIR ESC	110
Rpm indicator.....	110
Current and consumption display	111
Tension, current, RPM and temperature display.....	111

Appendix

Firmware update	112
Transmitter software update	112
Restoring the transmitter software	113
SIMPLIFIED DECLARATION OF CONFORMITY	114
Notes on environmental protection	115
Care and maintenance	115
Warranty certificate.....	115

Introduction

Thank you very much for purchasing a **Graupner** transmitter.

The transmitter manual is composed by two parts: Part 1, the printed short-manual, is included in the package. Part 2, the programming manual, can be found in its last version on **www.graupner.de** by the related page of the transmitter.

Read the manual carefully to use the transmitter optimally and first of all to safely control your models. If you experience any trouble during operation, take the instructions to help or ask your dealer or **Graupner** Service Centre.

Due to technical changes, the information may be changed in this manual without prior notice. Be always updated by checking periodically on our website, **www.graupner.de** to be always uptodate with the products and firmwares.

This product complies with national and European legal requirements.

To maintain this condition and to ensure safe operation, you must read and follow this user manual and all the safety notes before using the product and you have to respect those notes also for future use!



Note

This manual is part of that product. It contains important information concerning operation and handling. Keep these instructions for future reference and give it to third person in case you gave the product.

Service center

Graupner Central Service

Graupner/SJ GmbH
Henriettenstraße 96
D-73230 Kirchheim/Teck

Graupner USA
3941 Park Dr Suite 20-571
El Dorado Hills, CA 95762

Servicehotline

☎ (+49) (0)7021/722-130

Monday- Thursday:

9:15 am- 4:00 pm

Friday:

9:15 am- 1:00 pm

✉ **service@graupner.de**

Website: www.graupnerusa.com

Phone: +1 855-572-4746

Email: service@graupnerusa.com

Graupner in Internet

For the service centers outside Germany please refer to our web site **www.graupner.de**.

Intended use

This transmitter system must only be used for the purpose specified by the manufacturer for operation of remote control models without passengers. Any other type of use is impermissible and may cause significant property damage and/or personal injury. No warranty or liability is therefore offered for any improper use not covered by these provisions.

In addition, it is explicitly pointed out that you must inform yourself about the laws and regulations applicable at your respective starting point before starting the remote control operation. Such conditions may differ from state to state, but this must be followed in every case.



Note

Read through this entire manual before you attempt to install or use the transmitter.

Target group

The item is not a toy. It is not suitable for children under 14. The operation of the transmitter must be performed by experienced modelers. If you do not have sufficient knowledge about dealing with radio-controlled models, please contact an experienced modeler or a model club.

Package content

- Transmitter **mz-12 Pro HoTT**
- Transmitter LiPo battery 1S2P 3000mAh
- Transmitter strap
- Optional receiver
- Manual part 1
- Receiver manual (optional)



Note

Graupner constantly works on the development of all products; we reserve the right to change the item, its technology and equipment.

Symbol description

Always observe the information indicated by these warning signs. Particularly those which are additionally marked with the words **CAUTION** or **WARNING**.



The signal word **WARNING** indicates the potential for serious injury, the signal word **CAUTION** indicates possibility of lighter injuries.



The signal word **Note** indicates potential malfunctions.

Attention indicates potential damages to objects.

Safety notes



These safety instructions are intended not only to protect the product, but also for your own and other people's safety. Therefore please read this section very carefully before using the product!

- **Do not leave the packaging material lying around, this could be a dangerous toy for children.**
- **Persons, including children, with reduced physical, sensory or mental capabilities, or lack of experience or knowledge, or not capable to use safely the transmitter must not use the transmitter without supervision or instruction by a responsible person.**
- **Operation and use of radio-controlled models needs to be learnt! If you have never operated a model of this type before, start carefully and make yourself familiar with the model's reactions to the remote control commands. Proceed always responsibly.**
- **Protect all equipment from dust, dirt, moisture. All equipment must be protected from vibration as well as excessive heat or cold. The models may only be operated remotely in normal outside temperatures such as from -10°C to +55°C.**
- **Always use all your HoTT components only with the latest firmware version.**
- **If you have questions which cannot be answered by the operating manual, please contact us or another expert in the field.**

Foreword

The manual of this transmitter is made of two parts: The one named Part 1 quick guide is included in the package of the transmitter and this Part 2 in form of programming manual is always updated and is available as download in the web page of the related item on **www.graupner.de**.

Read both manuals carefully to use the transmitter optimally and first of all to safely control your models. If you experience any trouble during operation, take the instructions to help or ask your dealer or **Graupner** Service Centre.

To make the research of important information easier, the following paragraphs in this manual are marked with the related model type symbols. All five symbols in a row always mean "common property".



Otherwise, only the symbols suitable for the particular model type are represented.

Short-Cuts



The following key combinations can be used to call up certain menus and options:

CLEAR

Simultaneous touch of the left and the right keys of the left four way keypad will restore the active entry field's changed parameter value back to its default value.

"Servo display"

Brief activation of the VIEW key of the right four-way keys will cause a jump from the transmitter's base screen or from almost any menu position to the "Servo display" menu, (Pushing the ESC key of the right four-way keys you turn back to the related output point.)

"Telemetry" menu

Brief activation of the TLM key of the right four-way keys will cause a jump from the transmitter's base screen or from almost any menu position to the "Telemetry" menu, (Pushing the ESC key of the right four-way keys you turn back to the related output point.)

Graphic display of "telemetry" data

Pressing any of the selection buttons switches from the basic display to the "Telemetry data display" and from this display you can use the upper or lower selection buttons to call up the list of selectable sensors. Touching the ESC or ENT key will cause a return back to the base screen.

"HIDDEN MODE"

Simultaneously pressing the left, right, and bottom selection buttons of the left four-way keypad switches from the basic display of the transmitter and from almost any menu position to the "Hidden mode" menu, see manual Part 1.

Key lock

The four-way button fields and thus the access to any setting options can be blocked against accidental actuation. Press the TLM and VIEW buttons in the transmitter's base display for about one second. The lock symbol appears in the display. Press the TLM and VIEW buttons at the same time again for about two second to release the lock. The lock symbol is open in the display.

Definition of terms



Control function

A control function is understood as the signal for a specific control function. The signal of a control function can be transmitted directly into one control channel or through a mixer to several control channels. The control function includes the influence of the mechanical control path on the corresponding servo. This can be spread or concentrated and modified from linear to highly exponential.

Controls

As "control" are meant the function elements that the pilot can actuate directly in the transmitter. Through the controls the connected servos, ESC etc. will be controlled by the receiver.

Control channel

If a signal contains all control information necessary for a particular servo, whether directly from the control or indirectly via a mixer, then the term control channel is used.

Mixer

The transmitter software contains a variety of mixing functions. These allow a control function to influence several control channels and several servos. It is also possible to let several control function influence control channel (one servo).

Switch

The series of toggle switches can be included in the control programming. The switches are however generally also intended to switch program options such as to start and stop the timers, turn mixers on and off, as trainer switches etc. Each of the switches can be assigned any number of functions.

Meaning of the warnings



Battery
must be
charged !!

Transmitter voltage too low

BIND?
OK

Bind?
No receiver is bound to the actually active model memory. By tapping the ENT button you can accede the related option.

CAN'T
RECEIVE
ANY DATA
OK

No bound receiver in range.

RF ON/OFF?
ON OFF

Should the RF transmission be switched "ON" or "OFF"?
It appears only after switching the transmitter on with already bound receiver in active model memory.

SWITCH
RF
OFF
OK

Request to switch the RF transmission off

Fail-Safe
setting!

Fail Safe setting not performed yet

Throttle
too
high!

Throttle or pitch control stick position or throttle limit for helicopters too high

No
pupil
Signal

Connection between teacher and pupil transmitter disturbed

Switch-on warning
is active!!!

The transmitter has not been used within the last 10 minutes. In the display it appears the warning, the red Graupner logo LED blinks and an acoustic signal is emitted. If the transmitter is still not being used it will autonomously switch off after about three minutes.

Impossible now
low voltage

In case of too low battery voltage a model change is not possible for safety reasons. In the display appears a related message:

Please select
Trainer mode?
ON OFF

Should the "Wireless Teacher/pupil connection" used before the last switch off of the transmitter be continued (CONTINUE) or interrupted (INTERRUPT)?

Receiver assignation

The servos must be connected to the receiver in the indicated sequence. Not assigned outputs remain free.

Details about the receiver power supply can be found in the related receiver system manual.

Fixed-wing models



Motor-powered airplanes and glider models

with up to 2 aileron servos and 2 flap servos

Tail type "normal" or with "2 EL servos"

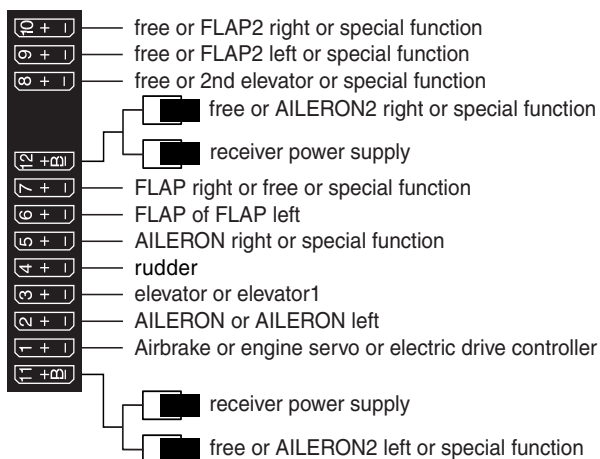

Tail type "V tail

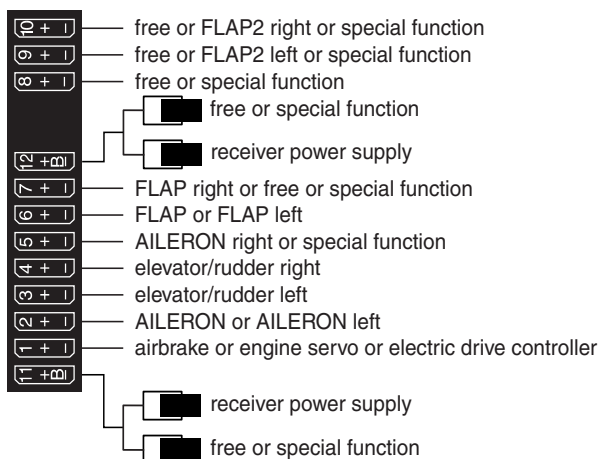

Delta/flying-wing models with and without motor

with up to 2 aileron/elevator servos and 2 flap/elevator servos

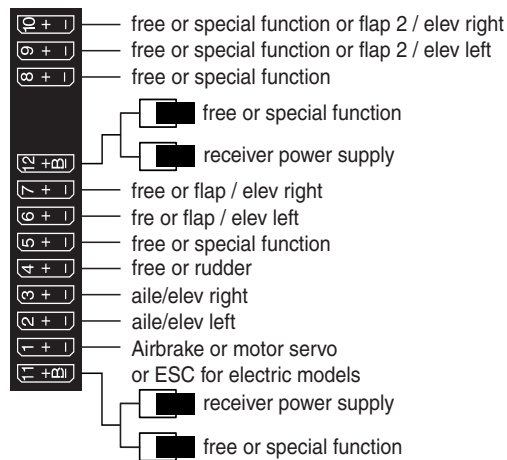

Due to the different installation of the servos and rudder linkages in the model, the direction for certain servos can be reversed.

V-Tail:

Servo with wrong direction of rotation	Solution
Reversed rudder and elevator	Change servo 3 + 4 direction
The rudder is correct and the elevator is reversed	Switch servos 3 + 4 on the receiver
Elevator correct, rudder reversed	Change servo 3 + 4 direction and switch them in the receiver

Delta or flying wing models:

Servo with wrong direction of rotation	Solution
The elevator and aileron are reversed	Change servo 2 + 3 direction
The elevator is correct and the aileron is reversed	Change servo 2 + 3 direction and switch them in the receiver
The aileron is correct and the elevator is reversed	Switch servos 2 + 3 on the receiver



with 1 to 3 swashplate servos

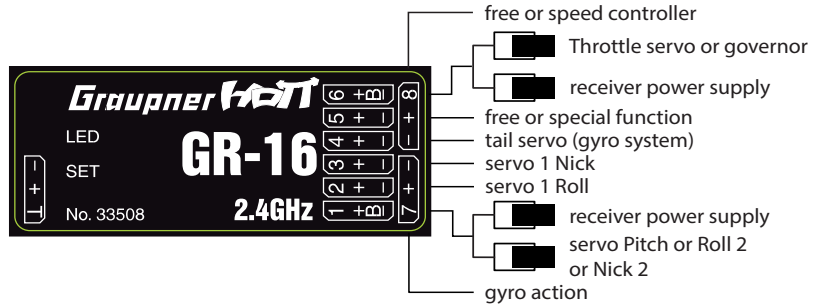

with 4 swashplate servos

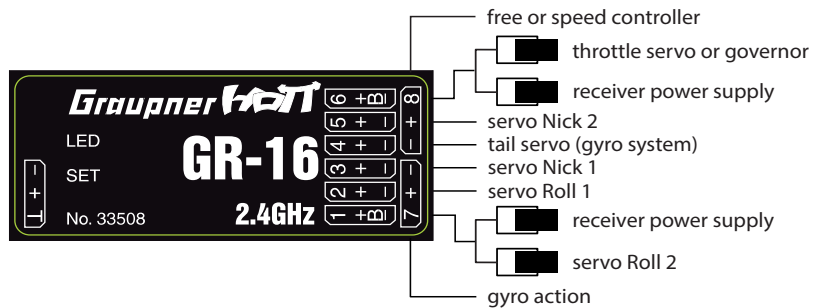

Note

Completely independent from the "classic" receiver configuration shown here, the connection notes in the installation instructions for the RC components involved must always be observed. Modern fly-barless systems, for example, often now have a sum signal input for PPM (SUMO for *Graupner* HoTT receivers) or SUMD (digital sum signal), so that a single connection cable is sufficient to establish a connection. However, the desired sum signal must be selected in the receiver as described at the end of the "Setting & data view" section of the "Telemetry" menu.

Land and water models

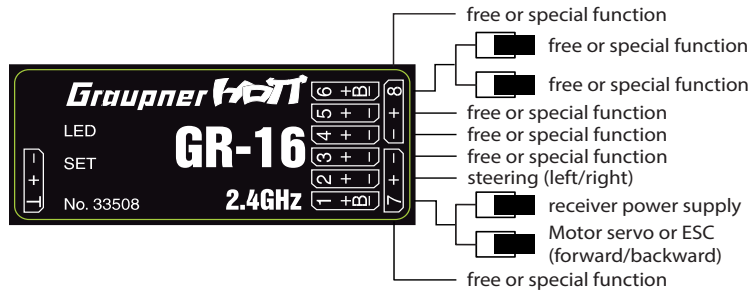

Copter

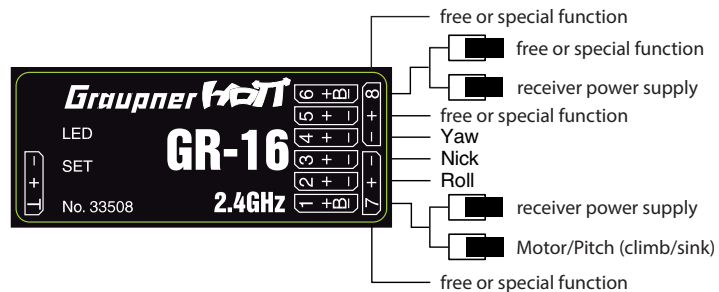

Note

Completely independent from the "classic" receiver configuration shown here, the connection notes in the installation instructions for the RC components involved must always be observed. Modern flight control of copters, for example, often now have a sum signal input for PPM (SUMO for **Graupner** HoTT receivers) or SUMD (digital sum signal), so that a single connection cable is sufficient to establish a connection. However, the desired sum signal must be selected in the receiver as described at the end of the "Setting & data view" section of the "Telemetry" menu.

Control, switch and control switch assignment



Controls assignment

In the "Ctl setting" menu, it is possible to assign to the transmitter-side inputs E5 to E12 or E5, Throttle, Gyr, E8 to E11 and Lim proportional rotary knobs as well as any of the 2 or 3 position switches mounted on the transmitter to control any servo.

Programming step-by-step

1. Move to the related column with the selection keys.
2. Move the desired switch or control to the OFF position.
3. Push the ENT key.
A notification window will appear.
4. Move the desired switch or control from the OFF to the ON position.
In the value field will appear the related denomination.

Move the desired
switch or control

This concludes the assignment.

Switch assignment

In the program points where a switch can be assigned, a switch symbol appears in the lower display line:

Programming step-by-step

1. Move to the related column with the selection keys.
2. Move the desired switch to the OFF position.
3. Push the ENT key.
A notification window will appear.
4. Set the desired switch from the OFF to the ON position.

Desired switch
in ON position

This concludes the assignment.

Deleting switches

After activating the switch assignment, as described above, simultaneously press the left and right selection buttons of the left four-way button (CLEAR).

Control switch

In the program of the transmitter **mz-12 Pro HoTT**, two so-called control switches are available on the CH1 control stick: A "G1" at approx. +90% and a "G2" at approx. -90% of the control course.

The assignment is performed as previously described under switch assignment. Only, instead of a switch, the CH1 control sticks is moved from the OFF position to the ON position.

Digital trim / Throttle switch-off trim



The two control sticks come with digital trimming. Briefly touch the trimming switch to move the neutral position of the control stick by a specific value with each click. If it is held, the trimming moves in the corresponding direction with increasing speed.

The current trimming values are automatically saved when the model memory is switched. In addition, the digital trimming functions within a memory in specific relation to the phase (with the exception of the trimming of the throttle/brake control stick (CH1).

In addition, the trimming of the throttle / brake control stick still has a special "shut-off trim", which is intended for combustion engines: If the trimming is a safe engine idle and from this position the trimming in a one shot till the end of the trimming course in the "stop motor" direction, then a further marking remains at the end position in the display.

On the next commissioning of the model, simply press the trim once in the "more throttle" direction to restore the trim to the last found idle setting.

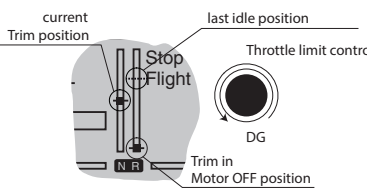
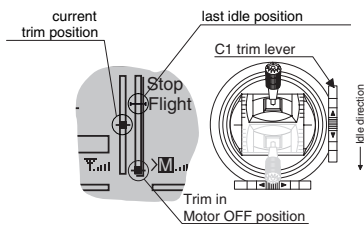

With the "Heli" model type, the CH1 trim in conjunction with the "Throttle limiter function" has a further property: As long as the throttle limiter is in the lower half of its setting range, CH1 trim acts as an idle trim on the throttle servo connected to output 6.

The throttle trim works only on the throttle, not on the pitch servos. Note also that the heli throttle servo must be connected to the output 6 of the receiver.

Menu description

The menus are described in the same sequence as they appear in the display.

Model memory



Model memory	M.Type Phase	Servo setting	Ctl setting
D/R Expo	Tx setting	C1 curve	Wing mix

Push the ENT key to recall the selection menu from the base display.

Push again the ENT button to recall the list of the sub-menus of the "Model memory" menu.

Push the ESC key to stop the procedure.

Model selection

▶ Model select	=>
Model name <	>
Delete model	=>
Copy Mod->Mod	=>
▼	⏏

Push the ENT button to recall the available model memories.

Push the ESC key to stop the procedure.

Model change

Use the upper or the lower key of the four-way key to select the desired model memory. Use the ENT key to confirm.



Notes

- For safety reasons, however, a receiving system, which may be in operation, must first be switched off.
- In case of too low transmitter voltage a model change is not possible for safety reasons.

Occupying a new model memory

01 ▶	⏏	M R08
02	**free**	
03	**free**	
04	**free**	
05	**free**	
06	**free**	

Select model type
(free model memory)
▼

Programming step-by-step

1. Select "Free" model memory.
2. Push the ENT key.
3. Select the desired model type through the selection keys.
4. Push the ENT key.

The selected model memory will be installed with the selected model type.

5. The display changes to the base display of the new assigned model memory.

In the base display the message, that there is no connection with a receiver, will appear for some seconds.

- Push the ENT key to open the "Rx bind" line of the menu "Tx setting". The binding of transmitter and receiver is described in the section with the same name.
- Push the ESC key to quit the message.



Note

If the actually active model memory is deleted, soon after the deletion process it must be defined a favorite model type. This selection can also be restored by switching the transmitter off. After all, the unwanted occupied model memory is to be erased from another memory.

Model name

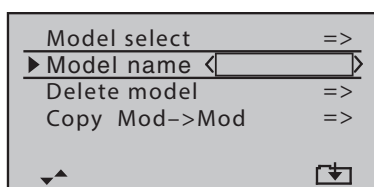

You can insert a maximum of nine characters for a model name of the active model memory. The entered model name is displayed in the basic display of the transmitter and in the model selection.

Push the ENT button to come back to the related sub-menu.

Push the ESC key to stop the procedure.

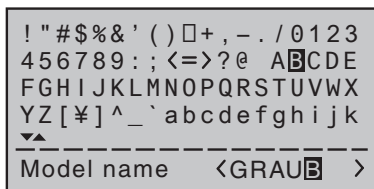

Programming step-by-step

1. Set the desired character through the selection keys.
2. Confirm the selected character through the ENT button.
3. Set the following character through the selection keys.
 - Simultaneously pushing the left and the right selection keys lets the cursor jump to the place where an empty space is.
 - Within the input field, any desired character position can be selected with the upper or lower selection key.
4. Press the ESC key to close the submenu.

Delete model

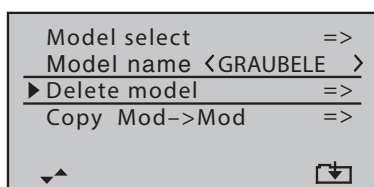

Push the ENT button to recall the occupied model memories.

Push the ESC key to stop the procedure.

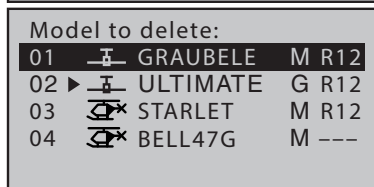

Programming step-by-step

1. Select the model to be deleted with the upper or lower selection button.
2. Confirm the selection by pushing the ENT button.
 - It appears a safety query.
3. Push the ESC key to confirm "NO" and stop the procedure.

Selecting "YES" with the right selection key and then pressing the ENT key will erase the selected model memory.

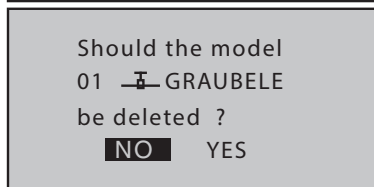



Notes

- This deletion cannot be restored. All of the data in the selected model memory are completely deleted.
- If the currently active model memory is deleted, a model type must be defined immediately afterwards. If an inactive model memory is deleted, soon after the model selection appears "***free***".

Copy Mod=>Mod

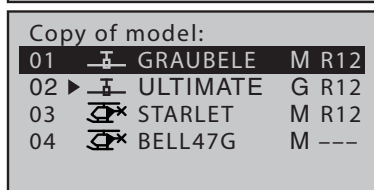
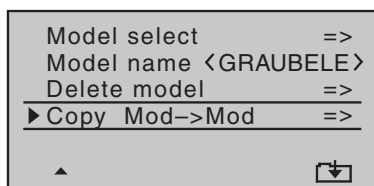

Push the ENT button to recall the occupied model memories.

Push the ESC key to stop the procedure.

Programming step-by-step

1. Select the model to copy using the selection keys.
2. Confirm the selection by pushing the ENT button.
3. Possibly, the warning message "Switch receiver OFF first" is displayed.
 - Push the ESC key to stop the procedure.
 - Push the ENT button to switch the RF off.



Note

For safety reasons, however, a receiving system, which may be in operation, must first be switched off.

4. Select the target memory using the selection keys.
5. Confirm the selection by pushing the ENT button.
 - It appears a safety query.
6. Push the ESC key to confirm "NO" and stop the procedure. Selecting "YES" with the right selection key and then pressing the ENT key will copy the selected model memory.

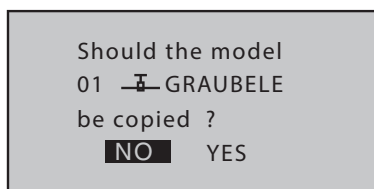

Model types/Phase



Model memory	M.Type Phase	Servo setting	Ctl setting
D/R Expo	Tx setting	C1 curve	Wing mix

▶ Model type	=>
Phase setting	=>
Phase trim	=>
▼	⏴

Push the ENT key to recall the selection menu from the base display.
Push the ESC key to stop the procedure.

Select the desired menu with the selection buttons, then press the ENT button again to recall the list of the submenu Model Type / Phase.

In this menu the "type" of the model to be programmed is defined. This also activates all the mixers, coupling functions, etc. characteristic of the type of the model, which are defined for the subsequent programming.



Note

The submenu "Phase trim" is only visible and selectable with the model type "Airplane".

Model type (Air, land and water models)

Motor on CH1



▶ Motor at C1	back
M.Stop -100% +150% ---	
Tail	normal
Aile./Flap	1AI
▼	

"None"

No drive motor is installed in the active model.

The brake system is retracted in the *front* position of the throttle / brake control stick (CH1), and the mixers "CH1 => N.N. *" in the "Wing mix" menu are activated.

The warning "Throttle too high!" is deactivated and the "Throttle cut" option is not shown in the display.

"back"

The idle position of the throttle/brake control stick (CH1) is in the backward position, in the pilot direction. The warning "Throttle too high!" is activated and the "Throttle cut" option is shown in the display.

"Front"

The idle position of the throttle/brake control stick (CH1) is in the forward position, in the opposite direction of the pilot. The warning "Throttle too high!" and the "Throttle cut" option in this menu are active.

"None/inv"

No drive motor is installed in the active model.

* N.N. = Nomen Nominandum (the name to be called)

The brake system is retracted in the *back* position of the throttle / brake control stick (CH1), and the mixers "CH1 => N.N. *" in the "Wing mix" menu are activated.

The warning "Throttle too high!" is deactivated and the "Throttle cut" option is not shown in the display.

Throttle Cut



Note

This option is not shown if "none" or "none/inv" is set in the line "Motor on CH1".

Motor at C1		back
▶ M.Stop	-100% +150% ---	
Tail		normal
Aile./Flap		1Al

With the help of this option, the throttle channel (CH1) is brought into a certain position after a switch has been actuated and held in this position. The motor can then no longer start, no matter in which position the throttle stick or the trim are.

The speed controller or the throttle servo only assume the set position after a switch has been activated and a specific switching threshold is undershot.

The throttle-cut or idle position is specified in the left-hand column and must be determined by tests.

In the middle column, the desired servo position (switching threshold) is set and a suitable ON / OFF switch is selected in the right column.

Activate the Throttle-cut function

- If the current servo position is *below* the switching threshold specified in the middle column, the switchover takes place as soon as the switch is moved to the ON position.
- If the current servo position is *above* the switching threshold specified in the middle column, the switchover occurs as soon as, after switching the switch to the ON position, the servo position falls below the switching threshold for the first time.

Deactivate the Throttle-cut function

- If the current servo position is *below* the threshold value specified in the middle column, then the speed controller or the throttle servo follows the CH1 control stick as soon as the switch is moved back to the OFF position.
- If the current servo position is *above* the switching threshold specified in the middle column, then the speed controller or the throttle servo follows the CH1 control stick as soon as it is moved back into the OFF position after switching the switch to the OFF position.

* N.N. = *Nomen Nominandum* (the name to be called)

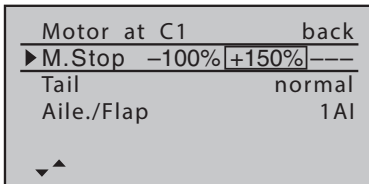
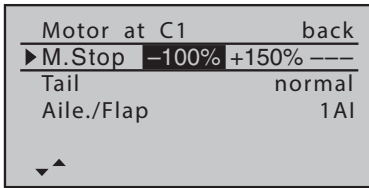

Programming step-by-step

1. In the left column of the "M-Stop" line, press the ENT key.
2. Use the selection buttons to set a value at which the motor is reliably "off".
 - In the case of an i.e. engine, care must be taken that the throttle servo does not run mechanically over.
3. Push the ENT key.
4. Use the right selection key to switch to the middle setting field.
5. The high default value of +150% in the middle column ensures that the motor can be stopped with the switch, to be assigned in the right column, over the maximum possible setting range of the servo travel or the speed controller.

|| If a lower switching threshold is to be set than the preset value of +150%, proceed as follows:

Move the throttle / brake control stick to the desired position and then press the ENT button.

After the switch is closed, the throttle servo or the speed controller is automatically switched to the motor-off position after the first trespassing of the switching threshold.

6. At the end assign a switch in the right column, through which (in case of emergency) the motor can be switched off or the switching threshold can be activated.



Note

A switching threshold of more than +100% is achieved by temporarily increasing the path on the plus side of servo 1 in the "Servo adjustment" menu to more than 100% and returning it to the original value after storing the switching threshold.

Tail plane



In this line, select the tail type that is appropriate for your model.

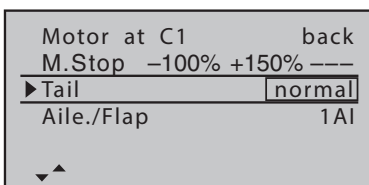

"normal"

The elevator and rudder are controlled each by one servo.

"V tail"

The elevator and rudder are controlled by two separately-articulated rudders arranged in a V-shape. The coupling function for the rudder and elevator control is automatically transferred from the program.

The action of the side-to-elevator ratio can be adjusted through the "Dual Rate / Expo" menu and the servo travel can be adjusted in the "Servo setting" menu.

"Delta/flying wing"

This option is only suitable for Delta and Flying wing models.

The aileron and elevator control are carried out through one or two servos each half-wing. The elevator and aileron trim acts according to your settings of "2AI 2FL" only on the servos 2 + 3, see table below.

"2 EL sv"

This option is indicated for models with 1 or 2 aileron and two elevator servos. When the elevator control is actuated, the servo connected to the output 8 works in parallel with servo 3. The elevator trim acts on both servos.

Ailerons/Flaps

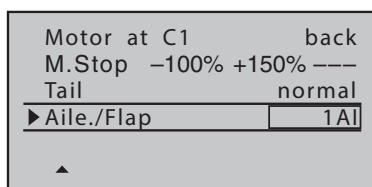

In this line you can select the number of servos installed in the wings. The following table shows the control channels to which the servos must be connected.

Control surfaces count	Occupied control channel
1AI	2
1AI 1FL	2 6
2AI	2 + 5
2AI 1FL	2 + 5 6
2AI 2FL	2 + 5 6 + 7

Programming Aile./Flap step-by-step

1. Select the line using the selection keys.
2. Push the ENT key.
3. From the list, select the appropriate count of ailerons and flaps for the model.
4. Press the ENT key to complete the operation.

According to this scheme the related required mixing options are activated in the "Wing mix" menu.

Model type (helicopter)



Swashplate type

► Swashplate	1 Servo
M.Stop	-100% +150% ---
Rotor direction	right
Pitch min	back
Autorotation	---
▼	STO ✓-

In case of helicopter models equipped with flybar systems, as a rule, there is no transmitter-side swashplate mixer, so when using such a system usually "1 servo" is to be selected as a type of swashplate.

In case of helicopter without Flybar system the count of servos which act on the swash plate has to be set.



Attention

In this context, it is essential to observe the adjustment instructions included with the Flybar system or the RC helicopter kit, as otherwise the heli may become non-flyable.

"1 servo"

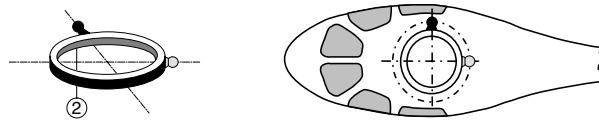

A flybar system is used or the swashplate is tilted by a roll and nick servo. A separate servo is used for the pitch control.

"2 servo"

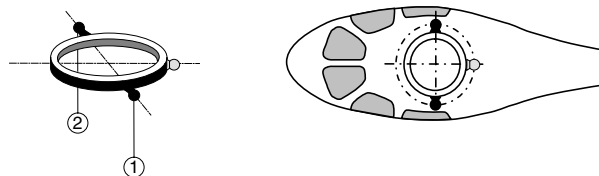

The swashplate is shifted axially for the pitch control by means of two roll servos. The nick control is decoupled by means of a mechanical compensation rocker.

"3sv (2Roll)"

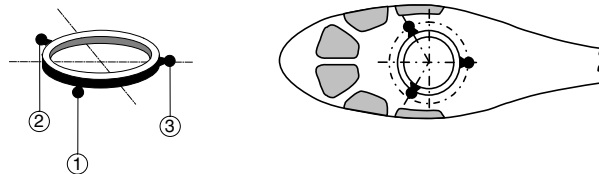

Symmetrical three-point control of the swashplate by means of three articulations points offset by 120°, by means of which one elevation servo (front or rear) and two roll servos (to the left and right side) are connected. All of the three servos of the swashplate shift axially for pitch control.

"3sv (140)"

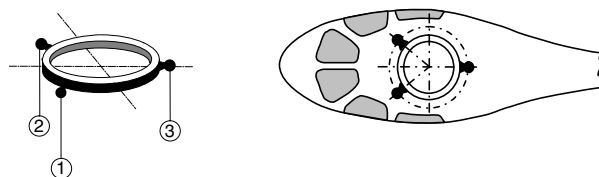

Asymmetrical three-point control of the swashplate by means of three articulations points offset, by means of which one nick servo (rear) and two roll servos (to the left side and right front) are connected. All of the three servos of the swashplate shift axially for pitch control.

"3sv (2Nick)"

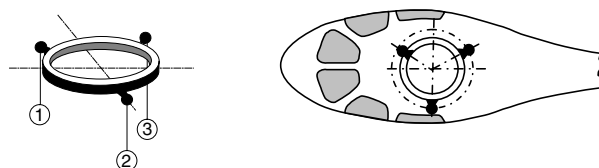

Symmetrical three-point axis as before, but rotated 90°; one roll servo on the side, and two nick servos, front laterally and rear. All of the three servos of the swashplate shift axially for pitch control.

"4sv (90°)"

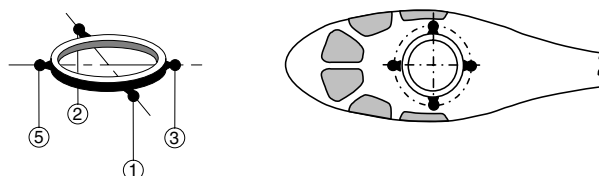

Four-point control of the swashplate by means of two roll servos and two elevation servos. All of the four servos of the swashplate shift axially for pitch control.

Throttle Cut

Swashplate	1 Servo
► M.Stop	[-100%] +150% ---
Rotor direction	right
Pitch min	back
Autorotation	---
▼▲	STO ✓-

With the help of this option, the throttle channel is brought into a certain position after a switch has been actuated and held in this position. The motor can then no longer start, no matter in which position the throttle stick or the trim are.

The speed controller or the throttle servo only assume the set position after a switch has been activated and a specific switching threshold is undershot.

The throttle-cut or idle position is specified in the left-hand column and must be determined by tests.

In the middle column, the desired servo position (switching threshold) is set and a suitable ON / OFF switch is selected in the right column.

Activate the Throttle-cut function

- If the current servo position is *below* the switching threshold specified in the middle column, the switchover takes place as soon as the switch is moved to the ON position.
- If the current servo position is *above* the switching threshold specified in the middle column, the switchover occurs as soon as, after switching the switch to the ON position, the servo position falls below the switching threshold for the first time.

Deactivate the Throttle-cut function

- If the current servo position is *below* the threshold value specified in the middle column, then the speed controller or the throttle servo follows the CH1 control stick as soon as the switch is moved back to the OFF position.
- If the current servo position is *above* the switching threshold specified in the middle column, then the speed controller or the throttle servo follows the CH1 control stick as soon as it is moved back into the OFF position after switching the switch to the OFF position.

Programming step-by-step

Swashplate	1 Servo		
► M.Stop	-100%	+150%	---
Rotor direction	right		
Pitch min	back		
Autorotation	---		
▼▲	STO	/ -	

Swashplate	1 Servo		
► M.Stop	-100%	+150%	---
Rotor direction	right		
Pitch min	back		
Autorotation	---		
▼▲	STO	/ -	

1. In the left column of the "M-Stop" line, press the ENT key.
2. Use the selection buttons to set a value at which the motor is reliably "off".
 - In the case of an i.e. engine, care must be taken that the throttle servo does not run mechanically over.
3. Push the ENT key.
4. Use the right selection key to switch to the middle setting field.
5. The high default value of +150% in the middle column ensures that the motor can be stopped with the switch, to be assigned in the right column, over the maximum possible setting range of the servo travel or the speed controller.

|| If a lower switching threshold is to be set than the preset value of +150%, proceed as follows:

Move the throttle / brake control stick to the desired position and then press the ENT button.

After the switch is closed, the throttle servo or the speed controller is automatically switched to the motor-off position after the first trespassing of the switching threshold.

6. At the end assign a switch in the right column, through which (in case of emergency) the motor can be switched off or the switching threshold can be activated.



Note

A switching threshold of more than +100% is achieved by temporarily increasing the path on the plus side of servo 1 in the "Servo adjustment" menu to more than 100% and returning it to the original value after storing the switching threshold.

Rotor direction

Swashplate	1 Servo
M.Stop	-100% +150% ---
▶ Rotor direction	right
Pitch min	back
Autorotation	---
▼▲	STO /-

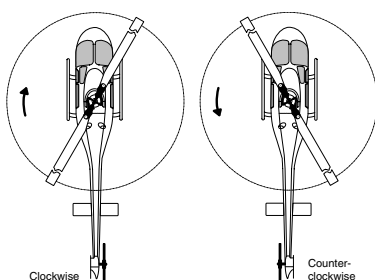

In the "Rotor direction" line, the main rotor rotation is entered:

- "right"
When viewed from above, the main rotor rotates clockwise.
- "left"
When viewed from above, the main rotor rotates counterclockwise.

Programming step-by-step

1. Push the ENT key.
2. Use the selection keys to select "left" or "right".
3. Push the ENT key.

Pitch min

Swashplate	1 Servo
M.Stop	-100% +150% ---
Rotor direction	right
▶ Pitch min	back
Autorotation	---
▼▲	STO /-

In the line "Pitch min", the operating direction of the throttle / pitch stick is adapted to the control habits.

- "front"
minimum pitch setting at the "front", the throttle / pitch control stick (CH1) points away from the pilot.
- "back"
minimum pitch setting at the "back", the throttle / pitch control stick (CH1) points to the pilot.

Programming step-by-step

1. Push the ENT key.
2. Use the selection keys to select "front" or "back".
3. Push the ENT key.

Autorotation

Swashplate	1 Servo
M.Stop	-100% +150% ---
Rotor direction	right
Pitch min	back
▶ Autorotation	---
▲	STO /-

The name "Autorotation" is fixed for Phase 3 and can NOT be changed. A switch can only be assigned to the right of the display, as described in the section "Control, switch and control switch assignment".

Phase setting (Air, land and water models)

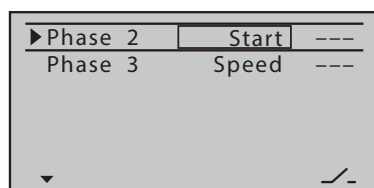
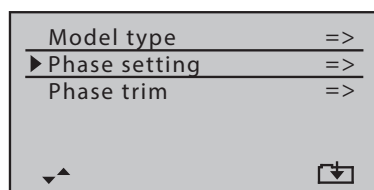

Push the ENT key to recall the setting page of this menu.

Push the ESC key to stop the procedure.

As long as no switch is assigned to phase 2 or phase 3, the transmitter is automatically in phase 1 "normal". Both the number and the name of this phase are fixed and can not be changed, which is why the «normal» phase is not displayed as phase 1, but remains hidden.

It should also be pointed out that the phases are preceded by priorities, which must be taken into account, in particular, in the assignment of individual switches. The underlying scheme can be described as follows:

- If all the phase switches that are assigned are closed or open, the "normal" phase is active.
- If only one switch is closed, then the phase which is assigned to the currently closed switch is active.

On the servo side, the changeover is not "hard", but with a fixed switching time of approx. 1 second.

"Phase 2" is preceded by the phase name "Start" and "Phase 3" by the name "Speed". This pre-setting may be left or modified as follows:

Programming the phase name step-by-step

1. *Select the desired value field using the selection keys.*
2. *Push the ENT key.*
3. *Select a suitable phase name among the ones appearing in the list.*
4. *Press the ENT key to complete the operation.*

As soon as at least one switch is activated in the right column, the name of the respective active phase is displayed in the basic display as well as in all menus where phase settings are adjustable and all phase-dependent settings made in the respective active phase are active.

Phase setting (helicopter)

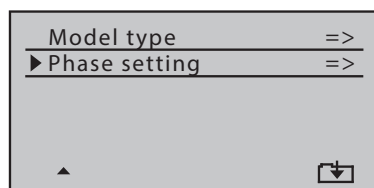

Push the ENT key to recall the setting page of this menu.

Push the ESC key to stop the procedure.

As long as no switch is assigned to phase 2 or autorotation phase, the transmitter is automatically in phase 1 "normal". Both the number and the name of this phase are fixed and can not be changed, which is why the «normal» phase is not displayed as phase 1, but remains hidden.

It should also be pointed out that the phases are preceded by priorities, which must be taken into account, in particular, in the assignment of individual switches. The underlying scheme can be described as follows:

- If all the phase switches that are assigned are closed or open, the "normal" phase is active.
- If only one switch is closed, then the phase which is assigned to the currently closed switch is active.
- The "autorotation phase" ALWAYS takes precedence over all other phases.

On the servo side, the changeover is not "hard", but with a fixed switching time of approx. 1 second.

"Phase 2" is preceded by the phase name "hover". This pre-setting may be left or modified as follows:

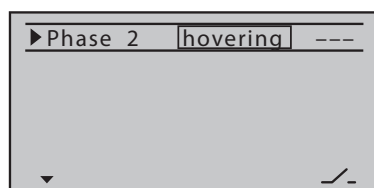

Programming the phase name step-by-step

1. Push the ENT key.
2. Select a suitable phase name among the ones appearing in the list.
3. Press the ENT key to complete the operation.

As soon as one switch is activated in the right column or in the line "Autorotation" of the "Model type" menu, the name of the respective active phase is displayed in the basic display as well as in all menus where phase settings are adjustable and all phase-dependent settings made in the respective active phase are active.

Phase trim (airplane)

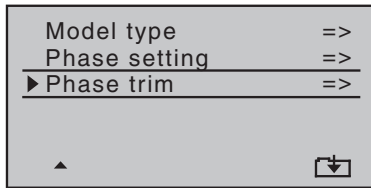

Push the ENT key to recall the setting page of this menu.

Push the ESC key to stop the procedure.

In this menu the phase-dependent positions of the control surfaces are entered. Depending on the settings made in the line "Aile./flap" of the "Model type" menu, it is available in this menu with only one "AI" and a maximum of three columns with "EL", "AI" and "FL".

PHASE TRIM			
*normal	0%	0%	0%
Start	0%	0%	0%
Speed	0%	0%	0%
	FL	EL	AI

Setting the trim value step-by-step

1. Use the phase switch to switch to the desired phase.
2. Move to the desired column with the selection keys.
3. Push the ENT key.
4. Use the selection buttons to set the desired control surfaces position.
5. Push the ENT key.
6. The remaining options have to be dealt with appropriately.

Motor OFF+timer

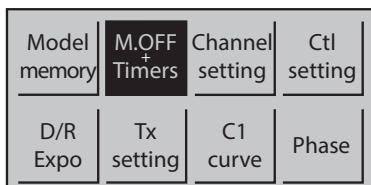

Select the desired menu using the selection buttons and then press the ENT button to enter the setup page of the menu.

Push the ESC key to stop the procedure.

Thr.HOLD

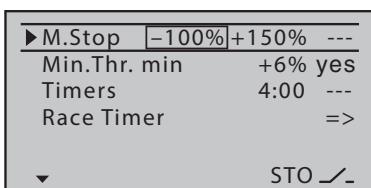

With the help of this option, the throttle/pitch (CH1) channel is brought into a certain position after a switch has been actuated and held in this position. The motor can then no longer start, no matter in which position the throttle/pitch stick or the trim are.

The speed controller of the copter only assume the set position after a switch has been activated and a specific switching threshold is undershot.

The throttle-cut or idle position is specified in the left-hand column and must be determined by tests.

In the middle column, the desired switching threshold is set and a suitable ON / OFF switch is selected in the right column.

Activate the Throttle-cut function

- If the current servo position is *below* the switching threshold specified in the middle column, the switchover takes place as soon as the switch is moved to the ON position.

- If the current servo position is *above* the switching threshold specified in the middle column, the switchover occurs as soon as, after switching the switch to the ON position, the servo position falls below the switching threshold for the first time.

Deactivate the Throttle-cut function

- If the current servo position is *below* the threshold value specified in the middle column, then the speed controller or the throttle servo follows the CH1 control stick as soon as the switch is moved back to the OFF position.
- If the current servo position is *above* the switching threshold specified in the middle column, then the speed controller or the throttle servo follows the CH1 control stick as soon as it is moved back into the OFF position after switching the switch to the OFF position.

Programming step-by-step

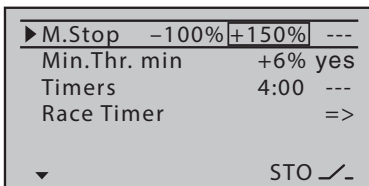
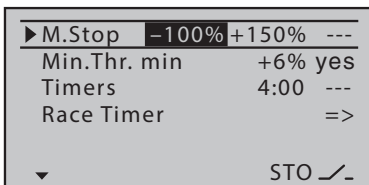

1. In the left column of the "M-Stop" line, press the ENT key.
2. Use the selection buttons to set a value at which the motors are reliably "off".
3. Push the ENT key.
4. Use the right selection key to switch to the middle setting field.
5. The high default value of +150% in the middle column ensures that the motors can be stopped with the switch, to be assigned in the right column, over the maximum possible setting range of the servo travel of the speed controller.

|| If a lower switching threshold is to be set than the preset value of +150%, proceed as follows:

Move the throttle/pitch control stick to the desired position and then press the ENT button.

After the switch is closed, all the speed controllers are automatically switched to the motor-off position after the first trespassing of the switching threshold.

6. At the end assign a switch in the right column, through which (in case of emergency) the motors can be switched off or the switching threshold can be activated.



Note

A switching threshold of more than +100% is achieved by temporarily increasing the path on the plus side of servo 1 in the "Servo adjustment" menu to more than 100% and returning it to the original value after storing the switching threshold.

Min.thr. min



Note

The settings of this option are effective only if a switch is assigned in the line "M-Stop" and this is open.

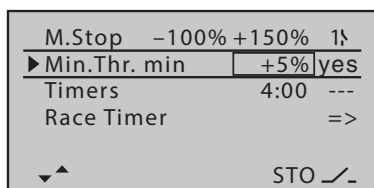

Depending on the choice "yes" or "no" in the right value field of the line "Min.thr. min", the default motor-off point can be moved in the range of $\pm 50\%$ with the % value on the left. Thus, for example, a certain minimum rotational speed of the rotors can be set for the descent. At the same time, the shifted point is the new zero point for the CH1 trim.

Programming step-by-step

1. Push the ENT key.
2. Set the desired %-value.
3. Push the ENT key.
4. Use the selection keys to switch to the right setting field.
5. Push the ENT key.
6. Use "yes" to activate this option, "no" to deactivate it.
7. Push the ENT key.

Timers

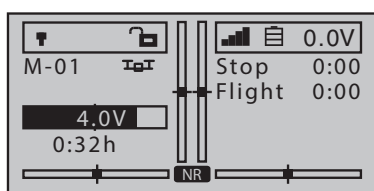

To the right of the basic display there are two clocks: a stopwatch and a flight or travel timer.

The stopwatch can optionally be forward or reverse. A reverse running stopwatch triggers acoustic signals from the transmitter in the last 30 seconds.

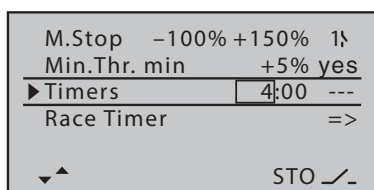

The flight or the drive timer always start together with the stopwatch but it continues to run when the stopwatch is stopped with the assigned switch. The flight or drive timer can only be stopped by pressing the ESC key when the stopwatch is stopped.

Pushing the left and the right selection buttons will reset the stopped timers to the default value.

Programming step-by-step

1. Push the ENT key.
2. Use the selection buttons to set the desired number of minutes.

3. Push the ENT key.
4. Use the selection keys to move to the seconds field.
5. Push the ENT key.
6. Use the selection buttons to set the desired number of seconds.
7. Push the ENT key.
8. Use the selection keys to switch to the switch field.
9. Push the ENT key.
10. Assigning the desired switch.

Race Timer

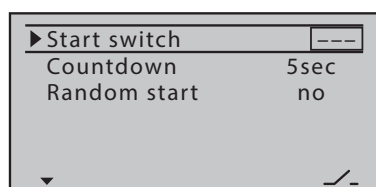
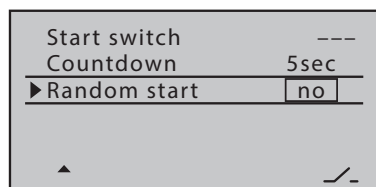
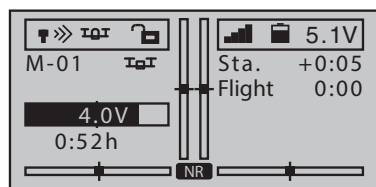
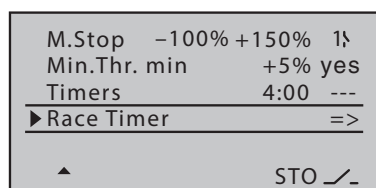

With this option the start of races can be trained:

When the start switch is pressed, the voice counts down a selectable period backwards to "0". A timer automatically starts when zero is reached and stops the elapsed time when the throttle / pitch control stick is actuated for the first time. This is shown in the display instead of the stopwatch until either the start switch is reset or the transmitter is switched off.

Two different start-up procedures are available:

- Random start "No"
The announcement will run smoothly until 0 seconds.
- Random start "Yes"
The time between announcement 1 and 0 is different.

Programming step-by-step

1. Push the ENT key to change to the setting page.
2. Assigning the desired start switch.
3. Use the lower selection key to change to the "Countdown" line if the default value is to be changed.
4. Push the ENT key.
5. Then use the selection keys to set a value between 10 and 0.
6. Push the ENT key.
7. Use the lower selection key to change to the "Random start" line, if necessary.
8. Push the ENT key.
9. Use the selection keys to select "yes" or "no".
10. Push the ENT key.
11. Use the ESC key to leave the setting menu.

Servo/channel setting



Model memory	M.Type Phase	Servo setting	Ctl setting
D/R Expo	Tx setting	C1 curve	Wing mix

Model memory	M.OFF timers	Channel setting	Ctl setting
D/R Expo	Tx setting	C1 curve	Phase

Select the desired menu using the selection buttons and then press the ENT button to enter the setup page of the menu.

Push the ESC key to stop the procedure.

In this menu, the parameters which exclusively affect the respective control channel or the connected RC component are set, namely the control direction, the neutral position and the control travel.

Programming step-by-step

1. Use the selection buttons to select the control channel to be set and, if necessary, the value field to be set.
2. Push the ENT key.
3. Use the selection keys to set the desired value.
4. Press the ENT key to complete the operation.
5. Proceed appropriately with the remaining value fields.

Column 1

▶S1 =>	0%	100%	100%
S2 =>	0%	100%	100%
S3 =>	0%	100%	100%
S4 =>	0%	100%	100%
S5 =>	0%	100%	100%
▼ Rev Centre	-	Trv	+

In the first column are listed the control channels 1 ... 12.

The numbers of the channel names refer to the RC components connected to the corresponding receiver outputs as long as the receiver outputs have not been interchanged.

A change in the control mode therefore does not influence the numbering of the servos.

Column 2 "Rev"

▶S1 =>	0%	100%	100%
S2 =>	0%	100%	100%
S3 =>	0%	100%	100%
S4 =>	0%	100%	100%
S5 =>	0%	100%	100%
▼ Rev Centre	-	Trv	+

With this option it is possible to adapt the control direction of the connected components to the specifics of each model.

The direction of rotation is symbolized by the symbols "=>" and "<=". The control direction must be set before setting the following options!

Column 3 "Centre"

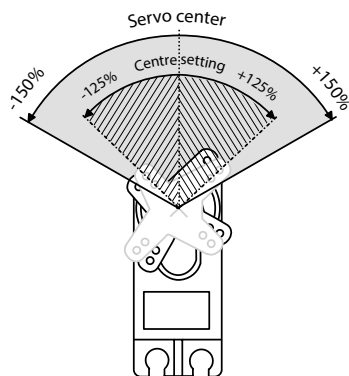

Within the control travel of maximum $\pm 150\%$, the control center can be shifted in the range of $\pm 125\%$. The servo is always adjusted directly independent of all other trim and mix settings.

▶S1 =>	0%	100%	100%
S2 =>	0%	100%	100%
S3 =>	0%	100%	100%
S4 =>	0%	100%	100%
S5 =>	0%	100%	100%
▼ Rev Centre	-	Trv	+

Column 4 "- Trv +"

In this column you can set the control travel, together or separated for each side. The setting range is 0 ... 150% of the normal control travel. The set values always refer to the settings in the column "Centre".



Note

If the neutral position is adjusted strongly, servo travel on one side may be restricted since the total travel is limited to $\pm 150\%$ for electronic and mechanical reasons.

Symmetrical travel setting

Move the related control element (control stick, proportional control or switch) into a position in which both sides of the travel adjustment are framed.

▶S1	=>	0%	100%	100%
S2	=>	0%	100%	100%
S3	=>	0%	100%	100%
S4	=>	0%	100%	100%
S5	=>	0%	100%	100%
▼ Rev Centre		-	Trv	+

Asymmetrical travel setting

Move the relevant control element (control stick, proportional rotary control or switch) to the respective side to be set so that the marking frame encloses only the value to be changed.

Control setting



Model memory	M.Type Phase	Servo setting	Ctl setting
D/R Expo	Tx setting	C1 curve	Wing mix

Select the desired menu using the selection buttons and then press the ENT button to enter the setup page of the menu.

Push the ESC key to stop the procedure.

The control channels 1 ... 4 are assigned to the stick control functions, which is why only the control channels 5 ... 12 can be assigned to other control elements of the transmitter.



Note for helicopter

In contrast to the designations E6, E7 and E12 of the displays of the four other model types shown in this section, the inputs are designated as Throttle, Gyr and Lim. The special requirements of these three inputs are discussed at the end of this section.

Programming step-by-step

1. Use the selection buttons to select the input to be set and, if necessary, the value field to be set.
2. Push the ENT key.
3. Use the selection keys to set the desired value.
4. Press the ENT key to complete the operation.
5. Proceed appropriately with the remaining value fields.
6. Push the ESC key to stop the procedure.

Column "Control"

►E5	free	+100%	+100%
E6	free	+100%	+100%
E7	free	+100%	+100%
E8	free	+100%	+100%
E9	free	+100%	+100%
▼		- Trv	+

The required switch or rotary control is assigned in this column.

The assignment takes place as described in the section "Control, switch and transmitter switch assignment".



Notes

- Even if misused, an unnecessary control element will not influence the model if it remains inactive, that is, when it has not been assigned a function.
- Settings in this menu affect all mixing and coupling functions that may be output, and thus ultimately to all RC components which are actuated via the related control element.

Column "- Trv +"

In this column you can set the control travel, together or separated for each side. The setting range is 0 ... 150% of the normal control travel.

E5	3	+100%	+100%
▶E6	DG	+100%	+100%
E7	free	+100%	+100%
E8	free	+100%	+100%
E9	free	+100%	+100%
▲		- Trv	+

Symmetrical travel setting

Move the related control element (proportional control or switch) into a position in which both sides of the travel adjustment are framed.

Asymmetrical travel setting

Move the relevant control element (proportional rotary control or switch) to the respective side to be set so that the marking frame encloses only the value to be changed.

Helicopter specific settings

Throttle

E5	free	+100%	+100%
▶Thr	free	+100%	+100%
Gyr	free	+100%	+100%
E8	free	+100%	+100%
E9	free	+100%	+100%
▼▲		- Trv	+

In contrast to the other four model types, the throttle servo or the speed controller of a helicopter is not directly controlled by the stick or another control but through a complex mixing system, see menu " ". In addition, the "Throttle limiter function" also has an influence on this mixing system. Therefore, this input is normally "free".

Gyro

E5	free	+100%	+100%
Thr	free	+100%	+100%
▶Gyr	free	+100%	+100%
E8	free	+100%	+100%
E9	free	+100%	+100%
▼▲		- Trv	+

Current Gyro systems have a stepless adjustability of the Gyro action as well as the possibility of switching between two different operating principles from the transmitter.

If the Gyro you are using has this option, you can specify its static gain or effect under form of an "Offset" in the "Gyro" line of the "Heli mix" menu.

The Gyro action can be varied around the respective "offset point" by means of a control assigned in the "Gyr" line of this menu, starting from these static settings, which are phase-specific in the "Heli mix".

In the middle position of the control, the Gyro action corresponds to the setting selected in the »Heli mix« menu. If the control is moved from this middle position in the direction of full throttle, this is correspondingly amplified and weakened in the direction of the opposite end point.



Attention

In this connection it is absolutely necessary to observe the adjustment instructions enclosed with the respective gyro, as otherwise the helicopter in question is non-flyable.

Lim

E8	free	+100%	+100%
E9	free	+100%	+100%
E10	free	+100%	+100%
E11	free	+100%	+100%
▶Lim	free	+100%	+100%
▲		- Trv	+

By the assignment of a control, for example of the control "DG", the option "Throttle limit" can be activated.

With an active throttle limiter, the increase of the system speed below the hover point is much more flexible and finer to optimize than by the so-called "Throttle selection" of other remote control systems. In addition, the programming of a "Throttle selection" phase, which is ultimately exclusively used to start the engine, becomes superfluous.

Programming step-by-step

1. Use the selection buttons to select the input to be set.
2. Push the ENT key.
3. Assign the throttle limit control, e.g. the DG proportional rotary control.
4. Push the ENT key.
5. Move to the "- Trv +" column with the selection keys.
6. Turn the control clockwise as far as the stop, so that the right value field of the column "- trv +" is framed.
7. Use the selection buttons to increase the value of the framed field to +125%.
 - This setting ensures that the full throttle position, accessible through the throttle curve setting of the "Helicopter mix" menu is not limited in any way.
8. Push the ESC key to stop the procedure.

E8	free	+100%	+100%
E9	free	+100%	+100%
E10	free	+100%	+100%
E11	free	+100%	+100%
▶Lim	free	+100%	+125%
▲		- Trv	+

Dual Rate / Expo



Model memory	M.Type Phase	Servo setting	Ctl setting
D/R Expo	Tx setting	C1 curve	Wing mix

Select the desired menu using the selection buttons and then press the ENT button to enter the setup page of the menu.

Push the ESC key to stop the procedure.

The dual rate/expo function allows you to switch or influence the control deflections and characteristics for the control functions of the control functions 2 ... 4. The basic functionality is the same in all of the five model types. Only the names of the three lines listed below are different:

Line 1	AI	Roll	ROLL	ST	ST
Line 2	EL	Nick	NICK	CH3	CH3
Line 3	RU	Tail	YAW	CH4	CH4

If phases are defined, the currently selected phase is displayed to the left of the display, and the respective settings only apply to the displayed phase.

Dual Rate

▶ AI	100%	0%	---
EL	100%	0%	---
RU	100%	0%	---
« normal »			
▼	DUAL	EXPO	↗

Dual rate acts directly on the corresponding control function, irrespective of whether this affects a single RC component or via arbitrarily complex mixing and coupling functions on several components.

This option can be selected in two stages and can be set between 0 and 125% of the normal control travel per switching position.

Expo

▶ AI	100%	0%	---
EL	100%	0%	---
RU	100%	0%	---
« normal »			
▼	DUAL	EXPO	↗

Expo also acts directly on the corresponding control function, irrespective of whether this affects a single RC component or via arbitrarily complex mixing and coupling functions on several components.

Expo allows a more sensitive control of the model in the central position of the respective control function (roll, elevation and tail) for values greater than 0% without having to do without the complete deflection in the end position of the control stick.

Conversely, the effect of the control around neutral position increases for values less than 0% and decreases in the direction of the full deflection.

The degree of this control travel influence can be switched over two stages and can be set between -100% and +100% for each switching position, where 0% corresponds to the normal linear control characteristic.

Combining Dual Rate and Expo

If both dual rate and expo values are set in one line, the settings are overlapped accordingly.

Programming step-by-step

1. Switch to the desired phase.
2. Use the selection buttons to select the line to be set and, if necessary, the value field to be set.
 - If a switch is to be assigned to a line, then the procedure should start with the switch assignment.
3. Push the ENT key.
4. Use the selection keys to set the desired value or activate the switch.
5. Proceed appropriately with the remaining value fields.
6. Push the ESC key to stop the procedure.

Transmitter setting



Model memory	M.Type Phase	Servo setting	Ctl setting
D/R Expo	Tx setting	C1 curve	Wing mix

Select the desired menu using the selection buttons and then press the ENT button to enter the setup page of the menu.

Push the ESC key to stop the procedure.

In this menu, the model-dependent basic settings of the transmitter are defined.

System menu - Control mode

► Control mode	1
Timers	0:00 ---
Rcv output	=>
Bind	---
Range test	99s
▼	

There are four different ways of assigning the four basic control functions of both sticks. The options that are chosen depend on the individual preferences of the model pilot.

Programming step-by-step

1. Push the ENT key.
2. Set the desired control mode through the selection keys.
3. Push the ENT key.

The possible control modes for the individual model types are:

Airplane

MODE 1 (throttle right)	MODE 2 (throttle left)
MODE 3 (throttle right)	MODE 4 (throttle left)

Helicopter

MODE 1 (throttle right)	MODE 2 (throttle left)
MODE 3 (throttle right)	MODE 4 (throttle left)

Land and water models

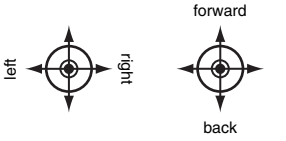
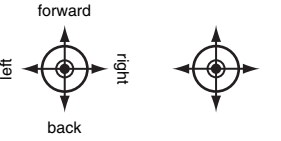
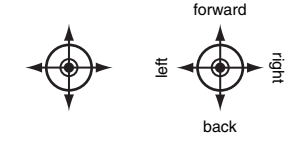
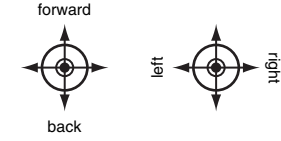
MODE 1 (throttle at right stick)	MODE 2 (throttle at left stick)
 <p>Diagram for Mode 1 (throttle at right stick): The left stick controls lateral movement (left/right) and the right stick controls longitudinal movement (forward/back).</p>	 <p>Diagram for Mode 2 (throttle at left stick): The left stick controls longitudinal movement (forward/back) and the right stick controls lateral movement (left/right).</p>
MODE 3 (throttle at right stick)	MODE 4 (throttle at left stick)
 <p>Diagram for Mode 3 (throttle at right stick): The left stick controls longitudinal movement (forward/back) and the right stick controls lateral movement (left/right).</p>	 <p>Diagram for Mode 4 (throttle at left stick): The left stick controls lateral movement (left/right) and the right stick controls longitudinal movement (forward/back).</p>

Copter

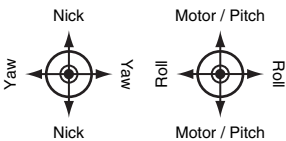
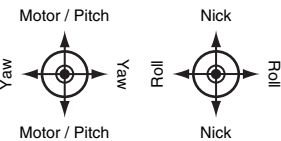
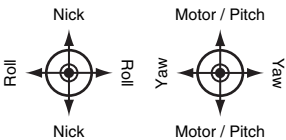
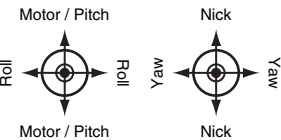
MODE 1 (throttle/pitch right)	MODE 2 (throttle/pitch left)
 <p>Diagram for Mode 1 (throttle/pitch right): The left stick controls Yaw (left/right) and Nick (up/down). The right stick controls Roll (left/right) and Motor/Pitch (up/down).</p>	 <p>Diagram for Mode 2 (throttle/pitch left): The left stick controls Motor/Pitch (up/down) and Nick (left/right). The right stick controls Yaw (left/right) and Roll (up/down).</p>
MODE 3 (throttle/pitch right)	MODE 4 (throttle/pitch left)
 <p>Diagram for Mode 3 (throttle/pitch right): The left stick controls Roll (left/right) and Nick (up/down). The right stick controls Yaw (left/right) and Motor/Pitch (up/down).</p>	 <p>Diagram for Mode 4 (throttle/pitch left): The left stick controls Motor/Pitch (up/down) and Roll (left/right). The right stick controls Yaw (left/right) and Nick (up/down).</p>

Timers



Note for copter

The menu item "Clocks", which is basically the same, is placed in the menu "M.Off + Timers" in the menu "Copter" and is therefore described in the same section (again).

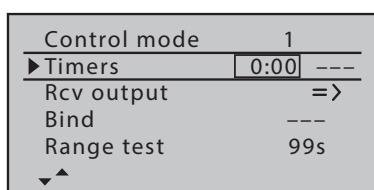
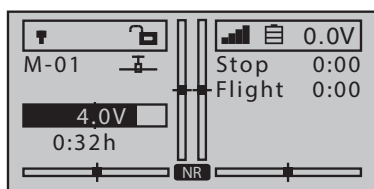

To the right of the basic display there are two clocks: a stopwatch and a flight or travel timer.

The stopwatch can optionally be forward or reverse. A reverse running stopwatch triggers acoustic signals from the transmitter in the last 30 seconds.

The flight or the drive timer always start together with the stopwatch but it continues to run when the stopwatch is stopped with the assigned switch. The flight or drive timer can only be stopped by pressing the ESC key when the stopwatch is stopped.

Pushing the left and the right selection buttons will reset the stopped timers to the default value.

Programming step-by-step

1. Push the ENT key.
2. Use the selection buttons to set the desired number of minutes.
3. Push the ENT key.
4. Use the selection keys to move to the seconds field.
5. Push the ENT key.
6. Use the selection buttons to set the desired number of seconds.
7. Push the ENT key.
8. Use the selection keys to switch to the switch field.
9. Push the ENT key.
10. Assigning the desired switch.

Receiver output

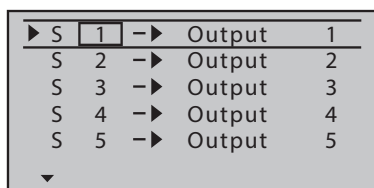
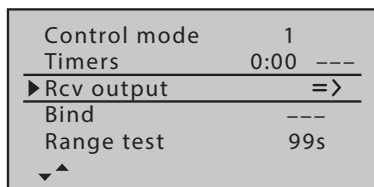

When the telemetry connection between the transmitter and the receiver is active, the default channel assignment within a receiver can be interchanged as desired.

Programming step-by-step

1. Push the ENT key.
2. Use the selection buttons to select the servo / output combination to be changed.
3. Push the ENT key.
4. Use the selection buttons to set the desired servo / output combination.

5. Push the ENT key.
6. Proceed appropriately with the remaining combinations.
7. Push the ESC key to come back to the output display.



Notes

- Before leaving the setting menu, check all settings for unintentional servo / output combinations.
- If the warning message "Can't receive any data" is displayed, there is no active telemetry connection between transmitter and receiver. Possibly the RF module and / or the receiving system must be switched on or the receiver must be bound as described below.

Control mode	2
Rcv output	=>
Bind	---
Range test	99sec
▶RF module	OFF

Bound receiver (binding)

Control mode	2
Rcv output	=>
▶Bind	---
Range test	99sec
RF module	OFF

To establish a connection with the transmitter, **Graupner** HoTT receivers must first be "bound" to at least one model memory in "its" **Graupner** HoTT transmitter. This process is generally called "binding" and it can be repeated all the times it is needed.

By default, the binding mode is "model" specific. As long as no receiver is bound to the model memory in question, this default can be changed to "global", see below under "Binding type".

Binding step-by-step

1. Switch on the power supply of the transmitter and the receiver to bind.
2. Ensure that there is a sufficient distance between the antennas of the two devices so that there is no overlapping of the return channel.
3. Eventually change to the "Tx setting" menu of the transmitter **mz-12 Pro HoTT** and there go to the line "Rx bind".
4. Bring the receiver in the binding mode according to the instructions.
5. Press the ENT button of the transmitter for about three seconds.
6. In the transmitter display, "BIND" is displayed rhythmically instead of the three hyphens.

▶Control mode	2
Rcv output	=>
Bind	---
Range test	99sec
RF module	OFF

If the binding process succeeds, the identification of the now bound receiver appears instead of the rhythmically flashing "BIND". Otherwise change the positioning of the devices and repeat the process.



Note

It is important to make sure that the receiver power supply is correct. If the power supply is too low, the receiver LEDs will react, as described in the related receiver manual, in response to your binding attempt, but the HoTT synchronization will not be performed.

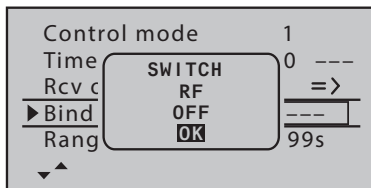

Other receiver binding

The model memory is already bound. This binding is to be replaced by another. After the binding process has been initiated, the message "Switch off HF" appears in the display instead of "BIND".

- Push the ENT key.
- Use the selection buttons to move two lines down, to the line "RF module".
- Push the ENT key.
- As described at the very end of the "RF module" section, turn the RF module OFF.

Delete a binding

As described in "Binding step-by-step", trigger a binding operation WITHOUT setting a receiver in the binding mode beforehand.

Range test

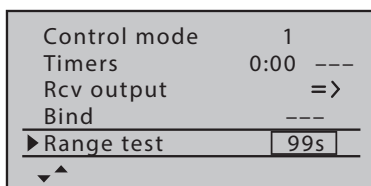

When the range test starts, the output of the transmitter decreases significantly. A practical functional test can therefore be performed at a distance of less than 100 m. After the the end of the range test, the transmitter switches back to full output power and the range test signal tone stops.

Eventually ask for help.

Range test step-by-step

1. Install the receiver, which preferably has already been bound to the transmitter, in the model.
2. Switch the transmitter on and wait until the receiver indicate according to the manual a correct function connection. Only now the servos can be moved.
3. Place the model on a flat surface (cement, mowed lawn or ground) so that the receiver antennas are at least 15 cm above the ground. It may therefore be necessary to place a support underneath the model during the test.
4. Hold the transmitter at hip level at a slight distance from your body. However, do not aim directly at the model with the antenna integrated into the right handle of the transmitter, but tilt the transmitter downwards or turn to the side so that this handle is approximately at right angles to the model during the test operation.
5. Push the ENT key.
 - The time display begins to run backwards and a beep sounds throughout the entire range test.
6. During the 90 seconds, walk away from the model and move the sticks.
 - If you notice an interruption in the connection at any time within a distance of about 50 m, try to reproduce it.

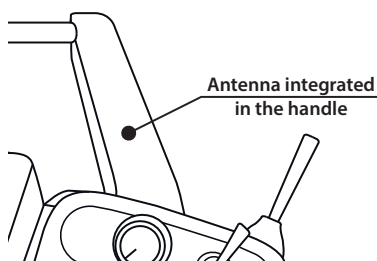

7. If possible, switch on an existing motor, in order to additionally check the interference resistance.
8. Move further away from the model until it does not respond perfectly any more.
9. At this location, wait for the remainder of the test period with the still operable model or push the WNT key to quit the test.
 - As soon as the range test has finished, the model should react to the controls movements. If this is not 100 % the case, do not use the system and contact your Service at **Graupner/SJ GmbH**.
10. Carry out the extended range test before starting up your model, simulating all the control movements occurring in practice. In order to guarantee a safe model operation, the range must always be at least 50 m on the ground.



CAUTION

- **Never start a range test on the transmitter during normal model operation!**
- **For physical reasons, the antenna integrated into the right handle of the transmitter forms a small field strength in a straight extension. In particular, if the model to be controlled is located at a greater distance and / or below the pilot location, the transmitter must be held so that the handle is approximately at a right angle to the model.**

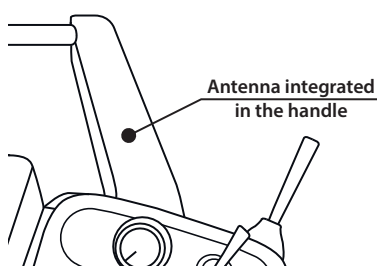

RF module

Timers	0:00	---
Rcv output	=>	
Bind		---
Range test	99s	
▶ RF module	ON	

If necessary, the RF emission of the transmitter can be switched on and off in this line.

Programming step-by-step

1. Push the ENT key.
2. Use the selection keys to select "ON" or "OFF".
3. Push the ENT key.

Binding type



Note

This menu line is only visible until NO receiver is actually bound to the active model memory.

Rcv output	=>
Bind	---
Range test	99s
RF module	ON
▶ Binding type	model
▲	

A non-bound model memory can be changed at any time from the default memory-specific HoTT synchronization to transmitter-specific, and vice versa.

- "Global", also all the transmitter specific bound receivers react to the signals of each model memory of "their" transmitter.
- "Model" specific bound receivers react exclusively to the signal coming from the specifically assigned model memory. An accidental use through a non specifically assigned model memory is NOT possible.

01	GRAUBELE	M	R12
02	▶ ULTIMATE	G	R12
03	STARLET	M	R12
04	BELL47G	M	---
05	Alpha 110	M	---
06	Xcell 220	M	---

The binding type assigned to a model memory is indicated in the model selection by an "M" or "G" to the right of the model name.

Programming step-by-step

1. Push the ENT key.
2. Use the selection keys to select "model" or "global".
3. Push the ENT key.

Throttle curve



Model memory	M.Type Phase	Servo setting	Ctl setting
D/R Expo	Tx setting	C1 curve	Wing mix

Select the desired menu using the selection buttons and then press the ENT button to enter the setup page of the menu.

Push the ESC key to stop the procedure.

Regardless of whether the CH1 control stick is acting directly on the corresponding RC component or via several mixers on several components, the control characteristics of the throttle / brake or pitch control stick can be changed with this option.



Note for helicopter

The curve characteristic set here also acts as an input signal to the "Pitch", "CH1 => Thr" and "CH1 => Tail" options of the "Helicopter Mix" menu.

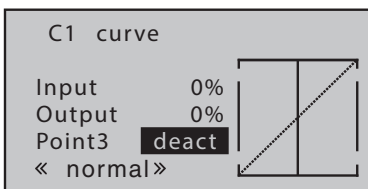

If phases have been provided with switches, this option may have to be adjusted phase-dependent. The respective phase name is displayed in the lower left corner of the display, e.g. "normal".

The control curve can be specified by up to 5 points, termed support points in the following, along the entire control stick travel: The graphic display makes it much easier to specify the support points and their adjustment. It is, however, recommendable to start with only three support points.

Use the control element to move a vertical green line between the two endpoints "Point1" and "Point5" in the graphic. The momentary control stick position is displayed numerically in the line "Input". The intersection of this mixer support line with the curve is identified as "Output" and can be varied at the support points between -125% and +125%.

Between the two endpoints, "point1" at -100% and "point5" at +100% of the control travel, up to three additional points can be defined at -50%, 0% and +50% of the control travel.

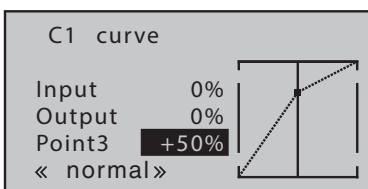

Setting or changing the support point step-by-step

1. Move the CH1 control stick to the desired position.
2. Use one of the selection buttons to set the desired value or activate the point and then set the value.
3. Proceed in the same way with the remaining points.
4. Leave the menu pushing the ESC key.

Deleting the support point step-by-step:

1. Move the CH 1 control stick to the point to delete.
2. Push simultaneously the left and the right selection keys.
3. Close the menu pushing the ESC key.

Wing Mix



Model memory	M.Type Phase	Servo setting	Ctl setting
D/R Expo	Tx setting	C1 curve	Wing mix

▶AI ->RU	0%	---
C1 ->EL	0%	---

▶AI-Diff.	0%	---
FL-Diff.	0%	---
AI ->RU	0%	---
AI ->FL	0%	---
C1 ->EL	0%	---
C1 ->FL	0%	---
C1 ->AI	0%	---
EL ->FL	0%	---
EL ->AI	0%	---
FL ->EL	0%	---
FL ->AI	0%	---
Diff.-Red.	0%	---

Select the desired menu using the selection buttons and then press the ENT button to enter the setup page of the menu.

Push the ESC key to stop the procedure.

The options available in the »Wing mix« menu are based exclusively on the number of aileron and flap servos set in the »Model type« menu: For example, only one option is available for the setting "1AI", whereas for the "2AI 2FL" type all twelve options are available, see pictures on the left.

Programming step-by-step

1. Select the desired line using the selection keys.
2. Push the ENT key.
3. Set the desired value.
 - Simultaneous pushing the left and the right selection will restore a changed value back to 0% in an inverted represented value field.
4. Push the ENT key.
5. Eventually use the selection key to change to the column above the switch symbol.
6. Push the ENT key.
7. Assigning the desired switch.
8. Use the remaining values in the same way.

Aile diff.

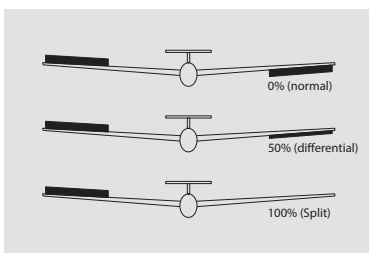

An aileron deflected downward generates greater resistance for aerodynamic reasons than one deflected upward. This unwanted collateral effect, referred to as a "negative reversing torque", is compensated by the use of a corresponding aileron differentiation. In this case, the path of the aileron, which moves downwards, is correspondingly reduced.

The adjustment range of $\pm 100\%$ allows you to adjust different deflection on the right side independent of the direction of rotation of the aileron servos. 0% corresponds to normal deflection (no differentiation), and -100% or +100% corresponds to the split function.

FLAP diff.

Analogously to the aileron differentiation, the flap differentiation causes the respective deflection downwards of the aileron function of the flaps, which is mixed via the mixer "AI => FL", to be reduced as well.

The adjustment range of $\pm 100\%$ allows you to adjust different deflection on the right side independent of the direction of rotation of the

flap servos. 0% corresponds to normal deflection (no differentiation), and -100% or +100% corresponds to the split function.

AI => RU

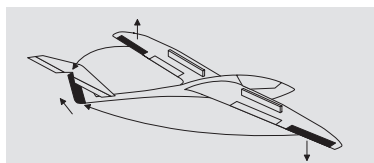

The rudder also moves to an adjustable degree when the aileron is actuated. This can compensate for the negative torque in conjunction with aileron differentiation, which smoothes flight in curves.

The rudder remains separately controllable.

The setting range of $\pm 150\%$ makes it possible to appropriately adapt the direction of deflection.

AI => FL

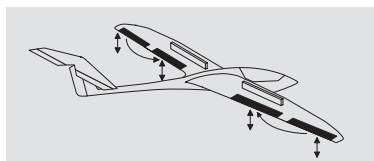

With this mixer, an adjustable portion of the aileron control is mixed into the flap channel. In the case of aileron deflection, the flaps then move in the same way as the ailerons. Normally, the flaps follow the ailerons with less deflection, that is, the mixed amount is less than 100%.

The setting range of $\pm 150\%$ makes it possible to appropriately adapt the direction of deflection to the ailerons depending on the direction of rotation of the flap servos.

C1 => EL

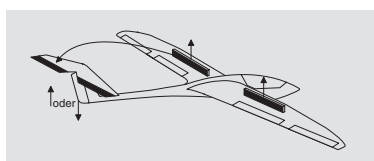

The flight speed of a model can be adversely affected, particularly when using a butterfly system, by the extension of the speed-breakers.

With this mixer, a correction effect can be compensated by adding a correction value on the elevator.

The adjustment range is $\pm 150\%$.

The selected setting must always be tested at a sufficient height, in particular, it must be ensured that the model does not become too slow when the brake system is extended! Otherwise, there is a danger that the model will slow down too much and, after the brake system is retracted (for example to lengthen a landing approach that is too short), will crash or fall.

C1 => FL

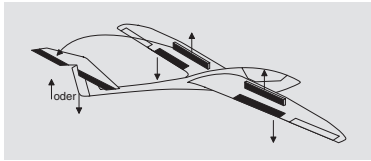

When the brake control function (C1 control stick) is actuated, both flap control servos can be individually adjusted for the landing between $\pm 150\%$ of the mixing ratio, usually downwards.

The value is normally selected so that when the brake control function is activated, the flaps move downwards as far as possible. Make sure, however, that the servos concerned do not run into the mechanical end point. Eventually, limit accordingly the servo travel with the "LIMIT- / +" option found on the "RX SERVO" menu of the "Telemetry" menu.

C1 => AI

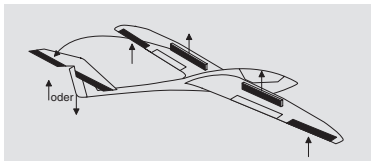

With this mixer, in case of actuation of the brake control function during the landing, both aileron servos are adjusted in the range of $\pm 150\%$, usually upwards.

EL => FL

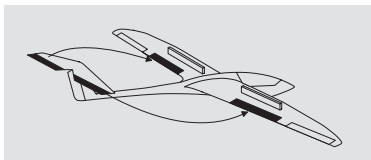

To support the elevator in tight curves and aerobatics, the flap function can be included by controlling the elevator with this mixer.

Select the mixing direction so that the flaps move downward when the elevator is pulled (up), and conversely upward when the elevator is pushed (down), that is, in an opposite direction.

The adjustment range is $\pm 150\%$.

EL => AI

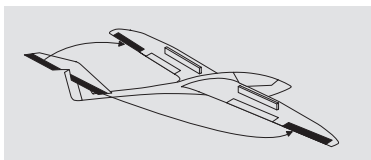

With this mixer you can support the elevator effect similar to the previous mixer.

The adjustment range is $\pm 150\%$.

FL => EL

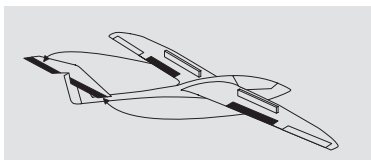

When setting flaps, upward or downward torque can arise about the transverse axis. It may also be desirable for the model to pick up the pace somewhat when slightly elevating the flaps. Both of these reactions can be achieved with the mixer.

When setting the flaps, you can use this mixer to have the position of the aileron automatically track the flaps depending on the set value.

The adjustment range is $\pm 150\%$.

FL => AI

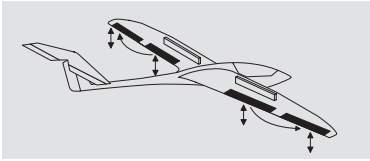

In order to achieve a more uniform buoyancy distribution over the entire span, an adjustable portion of the flaps control is transmitted to the ailerons channels 2 and 5 with this mixer. As a result, the ailerons move in the same way as flaps while these ones are moved, but normally with a smaller deflection.

The adjustment range is $\pm 150\%$.

Differentiation reduction

In the case of use of the aileron differentiation, the aileron effect can be severely impaired by the extreme positioning of the ailerons because, on the one hand, a further excursion of the higher aileron is no longer possible, on the other side the excursion of the downward moving aileron is also more or less affected by the adjusted differentiation. In addition, since the flight speed is also reduced during the landing approach, the aileron effect is noticeably limited in comparison to the "normal conditions".

In order to restore the reduction of the aileron effect as much as possible, you should use the automatic "reduction of the differentiation". This option reduces the degree of differentiation continuously and in an adjustable manner when the brake system is extended or even set them up, depending on the setting.

A 0% value means that the "Differentiation" programmed in the transmitter is held. A value equal to the set percentage of the differentiation means that this, in maximum brake function (with flaps completely out) is completely removed. In case of a reduction value bigger than the set aileron differentiation this will be removed completely before the full deflection of the flap control stick.

The adjustment range is 0 to 150%.

Helicopter mixer



ModEL memory	M.Type Phase	Servo setting	Ctl setting
D/R Expo	Tx setting	C1 curve	Heli Mixer

►Pitch	=>
C1 -> Thr	=>
C1 -> Tail	=>
Tail -> Thr	0%
Roll -> Thr	0%
Nick -> Thr	0%
Gyro suppression	0%
Gyro	0%
Sp limit	OFF
ESC at C8	no
ESC setting	50%
« normal »	⏴

Select the desired menu using the selection buttons and then press the ENT button to enter the setup page of the menu.

Push the ESC key to stop the procedure.

Helicopter mixer description

For the settings of the control curves of "Pitch", "C1 => Thr" and "C1 => Tail", 5-point curves are available. Also in this mixer can however only be programmed if required not linear mixer actions analogue to the control stick travels. In the "Autorotation" phase, on the other hand, the mixers "C1 => Thr" and "C1 => Tail" are not required and are therefore switched to an adjustable default value.

In the "Gyro" line, a value must be entered, analogous to the control centre adjustment or offset setting of other remote control systems. These setting options are rounded off with the "SP limit" option: Depending on the setting, this limits the maximum swing-out of the swash plate servos in the manner of a limiter.

If phases are provided with switches, the name of the respectively selected phase, e. g. "normal", in the "Heli mix" menu as well as in the base display of the transmitter. However, the change between the phases is not "hard" on the servo side, but with a fixed switching time of approx. 1 second. Only IN the autorotation phase is switched immediately.

Pitch

►Pitch	=>
C1 -> Thr	=>
C1 -> Tail	=>
Tail -> Thr	0%
Roll -> Thr	0%
« normal »	⏴

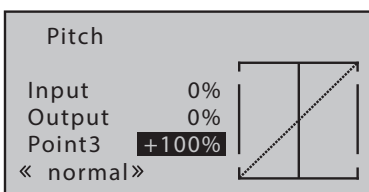

The control curve can be specified by up to 5 points, termed support points in the following, along the entire control stick travel: The graphic display makes it much easier to specify the support points and their adjustment. It is, however, recommendable to start with just a few support points.

Use the control element to move a vertical green line between the two endpoints "Point1" and "Point5" in the graphic. The momentary control stick position is displayed numerically in the line "Input". The intersection of this mixer support line with the curve is identified as "Output" and can be varied at the support points between -125% and +125%.

Between the two endpoints, "point1" at -100% and "point5" at +100% of the control travel, up to three additional points can be defined at -50%, 0% and +50% of the control travel.

Setting or changing the support point step-by-step

1. Push the ENT key to change from the selection list to the "Pitch" setting page.
2. Move the CH1 control stick to the desired position.

3. Use one of the selection buttons to set the desired value or activate the point and then set the value.
4. Proceed in the same way with the remaining points.
5. Leave the setting menu for the selection list pushing the ESC key.

Deleting the support point step-by-step:

1. Push the ENT key to change from the selection list to the "Pitch" setting page.
2. Move the CH 1 control stick to the point to delete.
3. Push simultaneously the left and the right selection keys.
4. Proceed in the same way with the remaining points.
5. Leave the setting menu for the selection list pushing the ESC key.

C1 => Thr

Pitch	=>
►C1 -> Thr	=>
C1 -> Tail	=>
Tail -> Thr	0%
Roll -> Thr	0%
« normal »	⏏

This setting only refers to the control curve for the throttle servo or the speed controller.

Similar to the setting of the pitch curve, see above, the throttle curve can also be defined by up to 5 points.

C1 => Tail

Pitch	=>
C1 -> Thr	=>
►C1 -> Tail	=>
Tail -> Thr	0%
Roll -> Thr	0%
« normal »	⏏

A torque compensation curve with a linear mixer ratio of 0% is uniformly set by default which is necessary for gyro sensors that operate in heading-lock mode, see the middle of the left representation. If you are using your gyro sensor in normal mode or the sensor can only handle normal mode, adjust the mixer as follows:

C1 -> Thr	
Input	0%
Output	0%
Point3	+0%
« normal »	⏏

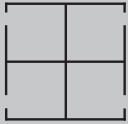

C1 -> Thr	
Input	0%
Output	0%
Point5	+30%
« normal »	⏏

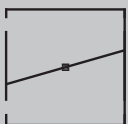

Setting the support lines step-by-step

1. Push the ENT key to change from the selection list to the "C1 => Tail" setting page.
2. Move the CH 1 control stick to the point 1.
3. Set point 1 to -30% with the selection keys.
4. Move the CH 1 control stick to the point 5.
5. Set point 5 to +30% with the selection keys.
6. Leave the setting menu for the selection list pushing the ESC key.

Adjust the mixer so that the helicopter does not rotate about the vertical axis, even during long vertical ascents and descents, as a result of differing main rotor torque in comparison to hovering.

Tail => Thr

Pitch	=>
C1 -> Thr	=>
C1 -> Tail	=>
▶Tail -> Thr	0%
Roll -> Thr	0%
« normal »	

The throttle is increased on one side where the tail rotor thrust is increased. The setting range is therefore only 0 to +100%. The direction is dependent on the rotation of the main rotor (left or right), which must be set correctly in the submenu "Model type" of the "Model type and phase adjustment" menu. In the case of left-rotating systems, the throttle is taken when the tail rotor control stick moves to the left, and to the right when the main rotor rotates to the right.

Mixer setting step-by-step

1. Push the ENT key to activate the value field.
2. Use the selection buttons to set the desired value or, by pressing the left and right selection buttons simultaneously, reset the current value to the default value "0%".
3. Press the ENT or the ESC key to complete the operation.

Roll => Thr / Nick => Thr

C1 -> Thr	=>
C1 -> Tail	=>
Tail -> Thr	0%
Roll -> Thr	0%
▶Nick -> Thr	0%
« normal »	

The throttle needs to follow an increase in pitch; likewise, the throttle should track with large cyclical control movements, that is, tilting a swashplate in a desired direction. In the **mz-12 Pro HoTT** transmitter programs, throttle tracking with roll, pitch and tail control can be attempted separately.

This is advantageous especially with aerobatics (for example when performing rolls) since cyclical control deflections are used with middle collective pitch values where the carburettor is about halfway open that require significantly higher motor output.

The mixer value can be set between 0 and +100 %. The correct mixer direction is automatically taken into account.

Gyro suppression

C1 -> Tail	=>
Tail -> Thr	0%
Roll -> Thr	0%
Nick -> Thr	0%
▶Gyro suppression	0%
« normal »	

If a gyro system is used in which the gyro can be adjusted via an additional channel from the transmitter, this option can be used to influence the effect of the gyro sensor ("gyro") as a function of the tail rotor actuation. The gyro suppression reduces the gyro's effect in a linear manner in proportion to the deflection of the tail rotor control stick corresponding to the set value.



Attention

This option may normally not be used for current standard gyro systems. In this connection it is absolutely necessary to observe the adjustment instructions enclosed with the respective gyro, as otherwise the helicopter in question is non-flyable.

Gyro

Tail -> Thr	0%
Roll -> Thr	0%
Nick -> Thr	0%
Gyro suppression	0%
►Gyro	0%
« normal »	

Most of the current gyro systems can be adjusted for a smooth, proportional effect; you can also choose between two different modes of action by the transmitter.

If the Gyro currently used in the model also has at least one of these options, this option offers the possibility of "normal" Gyro action as well as "Heading Lock" operation, analogue to the control centre adjustment or offset adjustment of other remote control systems.

The adjustment range of the "Gyro" line is $\pm 125\%$.

SP limit

Roll -> Thr	0%
Nick -> Thr	0%
Gyro suppression	0%
Gyro	0%
►SP limit	OFF
« normal »	

In the **mz-12 Pro HoTT** transmitter, the relevant software function offers a limitation of the swashplate deflection that can be adjusted between any combination of circular and square. This means that the limitation of the maximum tilting angle of the swash plate is proportionally variable between 100%- the deflection is circularly limited to the value attainable with roll or pitch alone - and 149%- no limitation effective. In addition, this function can also be deactivated completely by selecting "off". The SP limiter can be adjusted according to the phase.

Speed controller on CH8

Nick -> Gas	0%
Kreiselausbl.	0%
Gyro	0%
TS-Limit	AUS
►Regler an K8	nein
« normal »	

If a speed controller is used, this is usually connected to output 8 and the value field of this menu line must be set to "yes".

Programming step-by-step

1. Push the ENT key to activate the value field.
2. Use the selection keys to set "yes" or "no".
3. Press the ENT or ESC key to complete the input.



Note

If the setting "yes" is chosen, the control channel 8 cannot be used otherwise.

Speed controller setting

Gyro suppression	0%
Gyro	0%
SP limit	OFF
ESC at C8	no
►ESC setting	50%
« normal »	

After the option "ESC on C8" has been activated in the line with "yes", the rotor speed to be maintained by the controller can now be specified in a phase-specific manner by changing the % value in this line.

The adjustment range is 0 to 100%.

Programming step-by-step

1. Push the ENT key to activate the value field.
2. Use the selection buttons to set the desired value or, by pressing the left and right selection buttons simultaneously, reset the current value to the default value.
3. Press the ENT or ESC key to complete the input.

Phase



Model memory	M.OFF timers	Channel setting	Ctl setting
D/R Expo	Tx setting	C1 curve	Phase

Select the desired menu with the selection buttons, then press the ENT button again to recall the selection list of the menu.

Push the ESC key to stop the procedure.

Phase setting (copter)

► Phase setting	=>
Phase trim	=>
▼ [down arrow icon]	

Push the ENT key to recall the setting page of this menu.

As long as no switch is assigned to phase 2 or phase 3, the transmitter is automatically in phase 1 "normal". Both the number and the name of this phase are fixed and can not be changed, which is why the «normal» phase is not displayed as phase 1, but remains hidden.

It should also be pointed out that the phases are preceded by priorities, which must be taken into account, in particular, in the assignment of individual switches. The underlying scheme can be described as follows:

► Phase 2	Start	---
Phase 3	Speed	---
▼ [down arrow icon]		

- If all the phase switches that are assigned are closed or open, the "normal" phase is active.
- If only one switch is closed, then the phase which is assigned to the currently closed switch is active.

On the servo side, the changeover is not "hard", but with a fixed switching time of approx. 1 second.

"Phase 2" is preceded by the phase name "Start" and "Phase 3" by the name "Speed". This pre-setting may be left or modified as follows.

Programming the phase name step-by-step

1. Select the desired value field using the selection keys.
2. Push the ENT key.
3. Select a suitable phase name among the ones appearing in the list.
4. Press the ENT key to complete the operation.

As soon as at least one switch is activated in the right column, the name of the respective active phase is displayed in the basic display as well as in all menus where phase settings are adjustable and all phase-dependent settings made in the respective active phase are active.

Phase trim (copter)

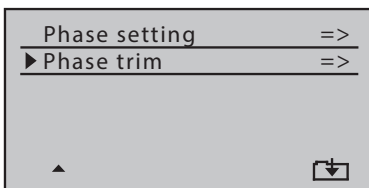

Push the ENT key to recall the setting page of this menu.

Push the ESC key to stop the procedure.

In this menu, you can enter the phase-dependent Nick control position.

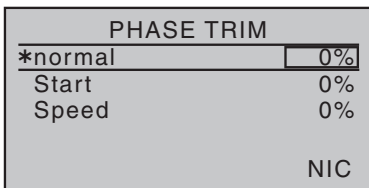

Setting the trim value step-by-step

1. Use the phase switch to switch to the desired phase.
2. Push the ENT key.
3. Use the selection keys to set the desired Nick value.
4. Push the ENT key.
5. Leave the setting menu for the selection list pushing the ESC key.

Free mixers



Model memory	M.Type Phase	Servo setting	Ctl setting
D/R Expo	Tx setting	C1 curve	free Mixer

Free Mixer	General setting	Fail-Safe	Trainer
An-nounce	Info display		

► M1	?? → ??		
M2	?? → ??		
M3	?? → ??		
M4	?? → ??		
M5	?? → ??		
▼	from		

M5	?? → ??		
C6	?? → ??		
C7	?? → ??		
C8	?? → ??		
► C9	?? → ??		
▼	from		

Push the ENT key to recall the selection menu from the base display. Select the desired menu with the selection buttons, then press the ENT button again to recall the setting list of the menu.

Push the ESC key to stop the procedure.

Regardless of the type of model chosen, in each model memory are available five linear mixers with the designation M1 to M5 as well as four curve mixers with the designation C6 to C9.

Mixer setting step-by-step

1. Select the desired mixer.
2. Push the ENT key.
3. Set the mixer input "From" through the selection keys:



- In a model memory of the type Airplane model, the control functions 1 ... 4 are marked as follows.

CH1	Throttle/speed-brake control stick
AI	Aileron control stick
EL	Elevator control stick
RU	Rudder control stick



- And in the other model types so:

1	Throttle/pitch/throttle + brake control stick
2	Roll/direction control stick
3	Nick control stick
4	Tail control stick



- **"S" as switch channel**

The letter "S" in the "from" column causes a constant input signal to be fed to the mixer input. With a switch assigned to this mixer, you can switch between two (still to be set) mixing values.

4. Move to the "To" column with the selection keys.
5. Select the mixer output "To" with the selection keys.
 - The identification of the control channels is analogous to the column "von".
6. Push the ENT key.
7. Use the selection keys to change to the left in the "Type" column and set for the control channels 1 ... 4, if the trim has to act on the mixer ("tr") or not("ooo").
8. Use the selection buttons to the right, to change to the column above the switch symbol and assign an ON / OFF switch to the mixer.
9. Proceed in the same way with the other mixers.

▶M1	tr	C1 → EL	---	=>
M2		?? → ??	---	
M3		?? → ??	---	
M4		?? → ??	---	
M5		?? → ??	---	
▼ Type	from	to	↙-	⏴

Linear mixer M1 ... M5 programming step-by-step

1. Use the selection buttons to select the line of the mixer to be programmed.
2. Move to the outer right column with the selection keys.
3. Push the ENT key.
4. If the display shows "Mixer ... OFF", the switch assigned to this mixer is in its OFF position. Move the switch:

▶M1		C1 → EL	---	=>
M2		?? → ??	---	
M3		?? → ??	---	
M4		?? → ??	---	
M5		?? → ??	---	
▼ Type	from	to	↙-	⏴

L.MIX1		C1→EL	
▶Trv	0%	0%	
Offs	0%		
▼	SYM ASY		

|| There is a vertical line in the graphic. This line represents the current position of the control element at the mixer input. (In the figure on the left, the line is located at the left edge of the graphic as the CH1 stick is located at the idle stop.)

The solid horizontal line indicates the mixing proportion, which is currently constant over the entire control travel.

The dotted vertical line indicates the position of the mixer neutral point, it is also called "offset". This is the point on the mixer guide line where the mixer does not actually affect the control channel. By default this point is in the control center.

The percentage of the mixing component is set symmetrically or asymmetrically in the "Trv" line and the offset point is changed in the "Offs" line under it.

5. Press the ENT key or first switch to the "ASY" field with the right selection key and then press the ENT key.
6. In the "Trv" line, use the selection buttons to set the degree of mixing component symmetrically or asymmetrically.
 - Simultaneously pressing the left and right selection buttons resets changed values to the default value.
7. Press the ENT key to complete the operation.

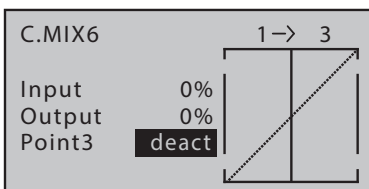
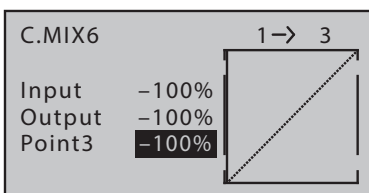
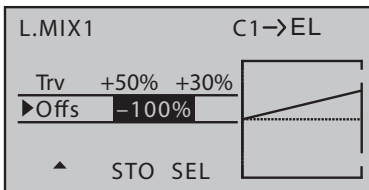
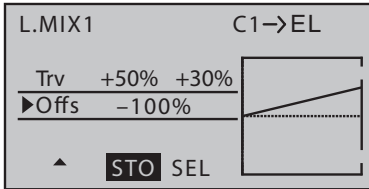
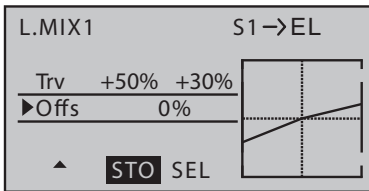

8. Use the lower selection key to change to the "Offs" line, if desired.

|| Instead of "SYM" and "ASY" at the lower edge of the display, "STO" and "SEL" are shown.

Pressing the ENT key while the (inverse) "STO" field is active ("Store" or "Save") saves the current control position as an offset position.

If, on the other hand, you switch to the "SEL" field with the right selection key and then press the ENT key, the inverse representation changes from the "SEL" field to the "Offs" line:

9. You can now either set an arbitrary offset value between $\pm 150\%$ with the selection buttons, or by pressing the left and right selection buttons simultaneously, a changed value can be reset to the default value.

10. Press the ENT key to complete the operation.

11. Press the ESC button to close the setting page and return to the mixer list.

12. Proceed in the same way with the remaining mixers.

Curve mixer C6 ... C9 programming step-by-step

1. As described above under "Programming linear M1 ... 5 step-by-step", select the required mixer and switch to its setting page.

|| There is a vertical line in the graphic. This line represents the current position of the control element at the mixer input. (In the figure on the left, the line is located at the left edge of the graphic as the CH1 stick is located at the idle stop.)

The dotted, oblique, line visualizes the characteristic of the mixer, which is still linear at the moment.

In the line "Point", the number of the currently activated point as well as its status "deactivated" or alternatively its setting value in percentage control travel is displayed.

Between the two endpoints, "point1" at -100% and "point5" at $+100\%$ of the control travel, up to three additional points can be defined at -50% , 0% and $+50\%$ of the control travel.

2. Move the solid vertical line with the corresponding control element to the point to be set.

3. Use one of the selection buttons to set the desired value or activate the point and then set the value. Alternatively, by pressing the left and right selection buttons simultaneously, you can reset a changed value to the default value.

4. Proceed in the same way with the remaining points.

Support points moving step-by-step

1. Move the solid vertical line with the corresponding control element to the point to be set.
2. Use the selection keys to set the desired value.
3. Proceed in the same way with the remaining points.

Support points deactivating step-by-step

1. Move the solid vertical line with the corresponding control element to the point 2 ... 4 to be set.
 - Both end points 1 and 5 cannot be deleted.
2. By simultaneously pressing the left and right selection buttons, the selected point can be reset to "deact."
3. Proceed in the same way with the remaining points.

General settings



Free Mixer	General setting	Fail-Safe	Trainer
An- nounce	Info display		

Push the ENT key to recall the selection menu from the base display. Select the desired menu with the selection buttons, then press the ENT button again to recall the setting list of the menu.

Push the ESC key to stop the procedure.

In this menu, transmitter-specific settings are defined.

▶Battery alarm threshold	3.4V
Key reaction	2
Contrast	0
Display light	always
RF Region	Europe
Voice volume	3
Signal volume	3
Back port	Ear
DATA sel.	Telemetry
DSC output	PPM10
USB joystick	0~100
▼	

Programming step-by-step

1. Select the desired value field or line using the selection keys.
2. Push the ENT key.
3. Use the selection buttons to set the desired value, or alternatively by pressing the left and right selection buttons reset a changed value to the default value.
4. Press the ENT key to complete the operation.
5. Proceed in the same way with the remaining lines.
6. Leave the menu pushing the ESC key.

Battery alarm threshold

▶Battery alarm threshold	3.4V
Key reaction	2
Contrast	0
Display light	always
RF Region	Europe
▼	



In this line, the warning threshold of the undervoltage warning is set in 0.1 volt steps between 3.4 and 4.2 V.

Make sure that the set value is not too low to give you sufficient time to land your model after a battery warning.

Attention

The transmitter mz-12 Pro HoTT is designed for operation only with a single-cell LiPo battery.

Key reaction

Battery alarm threshold	3.4V
▶Key reaction	2
Contrast	0
Display light	always
RF Region	Europe
▼▲	

The response to the key press of the left and right keypad is set in this line.

The setting range is from 1 (fast response) to 10 (slow response).

Contrast

Individual setting of the display contrast.

The adjustment range is from -20 to +20.

Display light

In this line, specify how long the background lighting of the display remains on after turning on the transmitter or since a control element has been actuated.

RF Region

Battery alarm threshold	3.4V
Key reaction	2
Contrast	0
Display light	always
▶RF Region	Europe
▼▲	

The region setting is necessary to meet various guidelines (FCC, ETSI, IC etc.).

It is therefore always appropriate to switch between "America" and "Europe".

Voice volume

Key reaction	2
Contrast	0
Display light	always
RF Region	Europe
▶Voice volume	3
▼▲	

In this line the volume of the voice announces is set.

The setting acts on the built-in speaker and the earphone connector.

The adjustment range is from 0 to 5.

Signal volume

Contrast	0
Display light	always
RF Region	Europe
Voice volume	3
▶Signal volume	3
▼▲	

In this line the volume of the signals is set.

The setting acts on the built-in speaker and the earphone connector.

The adjustment range is from 0 to 5.

Rear socket

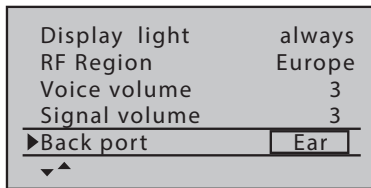

In this line you can select what the 3.5 mm jack socket on the rear of the transmitter is currently going to be used for:

- "Ear" for connecting an earphone.
- "DSC" to connect a Teacher/Pupil cable or to connect flight simulators.

DATA select

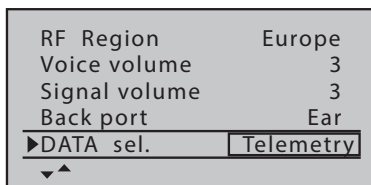

This line selects the output signal from the DATA jack:

- "Telemetry" to output the telemetry signals for a Smartbox No. 33700.
- "Bluetooth" to output the telemetry signals through the optional Bluetooth module No. S8351.

This module allows a Bluetooth connection to a suitable Android smartphone or tablet, or the optional OSD module No. 33641.

With the help of the "Graupner HoTT Viewer App for Android", the Android devices can receive telemetry data, display them and also send out warning messages.

DSC socket

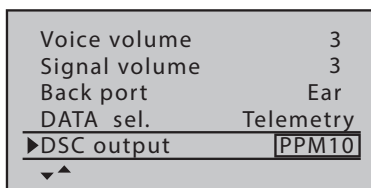

Selecting a specific PPM mode defines the number of the maximum control channels available on the DSC connector. It have the following meanings:

- PPM10: The output signal includes the control signals 1- 5.
- PPM12: The output signal includes the control signals 1- 6.
- PPM24: The output signal includes the control signals 1- 12.

USB joystick

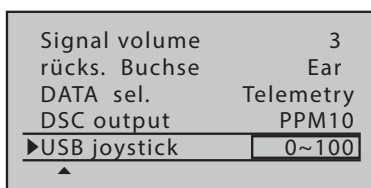

This setting is intended for the operation of the transmitter as a "joystick" with a PC flight simulator through the micro-USB port of the transmitter.

If a USB cable is plugged into the micro-USB socket of the **mz-12 Pro HoTT** transmitter and this is switched on, a corresponding selection window is displayed in the transmitter display for about 10 seconds.

Once "JOYSTICK" has been selected with the selection buttons of the transmitter and confirmed with the ENT button, or the window has then automatically closed in this display, the connected PC recognizes the transmitter as a joystick.

The standard setting suitable for the most flight simulators is 0% to 100%.

The adjustment range is from -100 to +100.

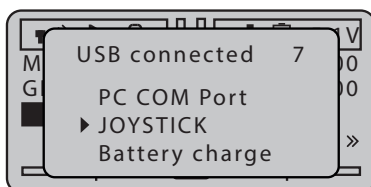

Fail-Safe



Free Mixer	General setting	Fail-Safe	Trainer
An- nounce	Info display		



Push the ENT key to recall the selection menu from the base display. Select the desired menu with the selection buttons, then press the ENT button again to recall the setting list of the menu.

Push the ESC key to stop the procedure.

The "Fail Safe" function determines the response of the receiver both by directly switching on the receiver system and when there is an interruption in transmission from the transmitter to receiver.

The RC components connected to the receiver outputs 1 to max. 12 can then ...

- ... after the receiver is powered on and until there is no valid signal from the transmitter, take the positions saved in the receiver. Completely independently from receiver settings "hold" or "pos".
- ... in case of interference ...
 - ... ("HOLD").
In case of transmission interruptions, all RC components programmed to "hold" remain at their position which was last identified to be correct until a new, correct control signal is received by the receiver.
 - ... after expiry of the preselected "delay time", move to the positions ("Pos") previously stored in the receiver.



Note

The standard setting, until a change occurs, is the central position.

Fail-Safe setting step-by-step

1. Use one of the selection buttons to select one of the control channels to be changed from "Hold" to "Pos", or vice versa.
2. Push the ENT key.
The symbolic switch changes the page accordingly.
3. Proceed in the same way with the remaining channels.
4. Switch to the value field "Delay" at the lower edge of the display with one of the selection keys.
5. Push the ENT key.
6. Use the selection keys to select the suitable delay time.
The following selections are available: 0,25, 0,5, 0,75 and 1 second
7. Push the ENT key.

8. Use one of the selection buttons to the right to change to the "STO" value field.
9. Now at the latest, switch on the receiver and wait for the transmitter and receiver to signal correct reception.
10. All RC components placed on "Pos" and / or those which are supposed to occupy a certain position during the switch-on phase of the receiving system must be placed in the desired positions at the same time via the respective control elements of the transmitter until the ENT key is pushed to store these settings as fail-safe settings in the receiver.
11. The successful storage of the data is shortly confirmed in the display, see representation on the left.
Otherwise check the correct radio transmission between your transmitter and receiver systems and repeat the process.

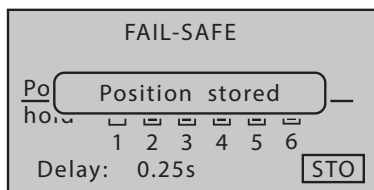

Attention

Since the fail-safe settings are stored exclusively in the receiver, they must be renewed after a receiver change and, in the event of a reset, be cleared in the previous receiver.

Teacher/Pupil

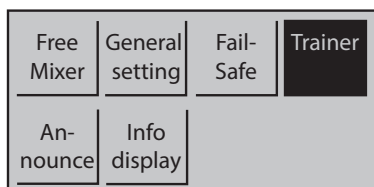

Push the ENT key to recall the selection menu from the base display. Select the desired menu with the selection buttons, then press the ENT button again to recall the setting list of the menu.

Push the ESC key to stop the procedure.

In this menu you can set the parameters for the teacher / pupil operation. With HoTT transmitters, both wireless and wired T/P operation are possible, always following the instructions of the pupil transmitter.

Preparing for training mode

Teacher transmitter

The model to be controlled by the pupil must be completely programmed, with all its functions, including trims and possible mixing functions, into a model memory of the teacher transmitter **mz-12 Pro HoTT** and tested for correct control behavior and the HoTT receiver of the respective model is "bound" to the teacher transmitter.

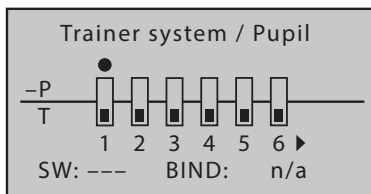

You can transfer up to twelve function inputs of a **mz-12 Pro HoTT** transmitter either individually or in any desired combination to a pupil transmitter.

The display line marked with the numbers 1 ... 12 identifies those control function inputs, with which the control functions 1 ... 4 (control stick functions) are permanently connected as well as the inputs 5 ... 12 which can be assigned freely in the "Control setting" menu.

The display line labelled "L" identifies the control function inputs which are reserved for the teacher, and the ones marked with "S" for the pupil.

Programming step-by-step

1. Use the selection buttons to select the first of the function inputs to be released to the student.
2. Push the ENT key.
The symbolic switch changes the page.
3. Proceed in the same way with the remaining function inputs.
4. Use the selection keys to move to the switch field in the left lower part.
5. Push the ENT key.
6. Assign a switch, preferably one of the self-restoring ones.
 - With the switch assignment, the transmitter is automatically defined as a "teacher", which means that this field must always be "empty" for a student transmitter.

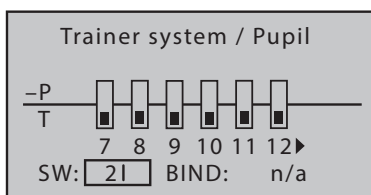

PUPIL transmitter settings



Attention

During the T/P operation, the control functions of the student transmitter **MUST** act directly on the control channels of the teacher's transmitter without the intermediary of any mixers.

A free model memory must be activated with the required model type, the model name "pupil" and the control arrangement (Mode 1 ... 4) as well as "Thr.min" or "Pitch min front / back" should be adapted to the pupil's habits. All other settings as well as all mixing and coupling functions are made in the TEACH transmitter and are transmitted by the TEACH transmitter to the receiver.

If, in addition to the functions of the two crossbars (1 ... 4), further control functions are to be transferred to the student, control elements may be assigned to these inputs. Otherwise, the affected servo remains or the servos concerned remain in the middle position for the duration of the transfer to the student transmitter.

Observe the standard conventions when assigning control functions.

Trainer mode with DSC cable



Notes

- A wired teacher-student operation with **mz-12 Pro HoTT** transmitters is possible only as long as in the value field of the line "Back port" line of the "base settings" menu the option "DSC" is set.
- For pupil transmitters of the type **mx-20**, **MC-16**, **MC-20** or **MC-32** HoTT, the modulation type "PPMxx" is indicated in the line "DSC output" of the "Model base settings" menu to adapt a student to the control channels.

Trainer mode

Connect both transmitters via the DSC cable and check all functions for correct transfer at the ready-to-go model before starting the T/P function.

Functional test

Press the assigned teacher-pupil switch:

The teacher-pupil system works perfectly when the display changes from "*T" to "*P" in the teacher's transmitter.

If, on the other hand, the central LED of the teacher's transmitter flashes red and a beep sounds simultaneously, the connection between the teacher and the pupil transmitter is interrupted.

At the same time, the warning message "No pupil signal" appears in the base display of the teacher's transmitter and in the "teacher / pupil" menu, the display on the left changes to "-S". In this case, regardless of the current position of the T/P switch, all control functions remain automatically at the teacher transmitter, so that the model will not be uncontrolled at any moment.

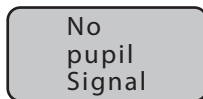

Wireless HoTT system

Preparing the wireless T/P mode step-by-step

1. Switch on both transmitters with activated RF module.
2. Open the respective T/P menu in both transmitters.
3. PUPIL transmitter
 - Use the selection buttons to move the marking frame to the "BIND" input field at the bottom right of the display. If a switch is to be shown to the right of "SW:", it must first be erased, as shown in the figure on the left.
4. Teacher transmitter
 - Use the selection buttons to move the marking frame to the "BIND" input field at the bottom right of the display.
5. First in the pupil transmitter and then in the teacher transmitter start the binding process by pushing the respective ENT key.

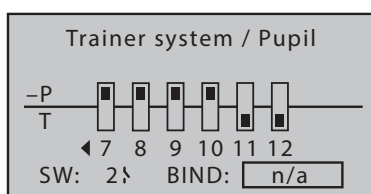
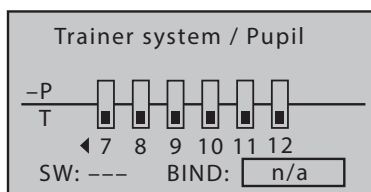

Once this process has concluded, "ON" appears in both displays instead of the flashing "BIND"

Both transmitters can then return to the basic display and commence training after a thorough check of all functions.

If only one or neither transmitter displays "ON" indicating that the binding process failed, change the positions of the two transmitters and repeat the entire procedure.

Training operations

During the training mode teacher and pupil can maintain a comfortable distance. The "earshot" distance (a maximum of 50 m) should not be exceeded, and no one should be between the teacher and pupil since this would reduce the range of the feedback channel used to connect the two transmitters.

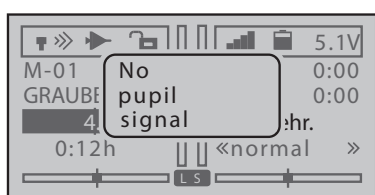

If the connection to the teacher transmitter is completely lost and the T/P switch is in the "pupil" position, the **Graupner** logo of the teacher's transmitter starts to flash in a frantic red for the duration of the signal loss and acoustic warning signals are emitted. In addition, "RFC-" flashes in the basic display and the warning message "No pupil signal" is shown in the display.

In such a case you should provide a smaller distance between both transmitters. If it does not help, you should immediately stop the use of the model and search for the reason.

Announce

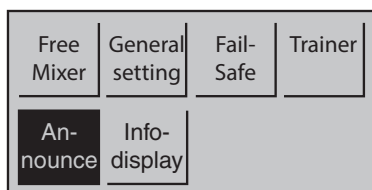

Push the ENT key to recall the selection menu from the base display. Select the desired menu with the selection buttons, then press the ENT button again to recall the setting list of the menu.

Push the ESC key to stop the procedure.

The transmitter is delivered with a basic selection of voice announcements. This selection can be supplemented by self-generated announcements in .wav or .mp3 format using the "Firmware_Upgrade_grStudios" program from the PC or laptop.

In the seven lines of this menu, one announcement can be assigned to each of the two switching positions of a switch.

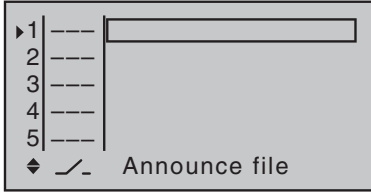

Programming step-by-step

1. Use the selection keys to select the desired line.
2. Assign the desired switch in the line upon the switch symbol "↗".
3. Use the right selection key to switch to the right-hand column.
4. Push the ENT key.
5. Use the selection keys to select the desired announce.
6. Press the ENT key to complete the operation.
7. Proceed appropriately with the remaining lines.
8. Leave the menu pushing the ESC key.

Info display

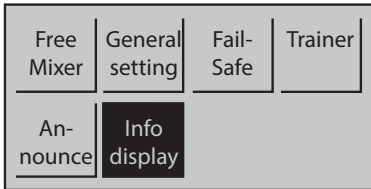

Push the ENT key to recall the selection menu from the base display. Select the desired menu with the selection buttons, then press the ENT button again to recall the setting list of the menu.

Push the ESC key to stop the procedure.

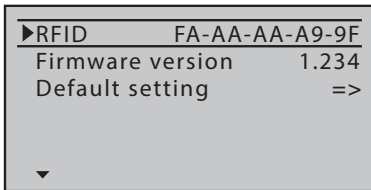

In this menu, transmitter-specific information is displayed and it is possible to reset the transmitter to the delivery state.

RFID

The RFID of the transmitter is displayed in this line. This ID is specific for each transmitter, is only issued once per transmitter, and cannot be changed.

Firmware version

The current version number of the transmitter software is displayed in this line.

The version number could be required for service inquiries.

Default setting

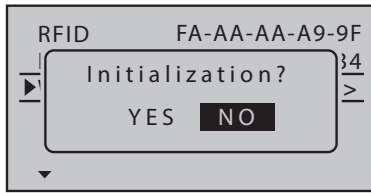

- Confirming the "NO" setting by pressing the ENT key will quit the operation.
- Pressing the ENT key after changing to "YES" resets the transmitter to the factory settings.

All model memories and other settings are erased and copter model memories programmed at the factory are restored.

Telemetry



Receiver settings and the displays and settings of the connected telemetry sensors can be retrieved and programmed in real time in the "Telemetry" menu.

The connection to the receiver is maintained by the feedback channel of the HoTT receiver. The exchange of telemetry data between transmitter and receiver takes normally place only after each four RC data-packs. Therefore also the reaction to control buttons or setting changes has normally within a telemetry connection a delay. This does not constitute an error.



Attention

- The model or sensors may only be programmed when the model is on the ground. Only perform settings when the motor is turned off or the drive battery is disconnected.
- All settings that have been made using the "Telemetry" menu (such as fail safe, reversal of the direction of servo rotation, servo travel, mixer and curve settings, etc.) are only saved in the receiver and are therefore transferred to other models when the receiver is switched. You therefore need to reinitialize your HoTT receiver if you want to use your receiver in another model.

The menus grouped under the definition "Telemetry" can be recalled at any time by pushing the VIEW key of the right four-way keys from the base display so as from almost every other menu positions.

Basic operation

Basically the "Telemetry" menu corresponds to the other menus of the **mz-12 Pro HoTT** transmitter: The few deviations are described below:

```
RX FAIL SAFE V6.37 <>
>OUTPUT CH: 01
INPUT CH: 01
MODE      : HOLD
F.S.Pos.  : 1500µsec
DELAY     : 0.75sec
FAIL SAFE ALL: NO
POSITION  : 1500µsec
```

- Analogously to the directional arrow in the upper right of the display (< >) the right or left selection key is used to switch between the individual pages of the "telemetry" menu.
If there is only one angled bracket, the first or last page is active in the menu. You can then only change pages in the displayed direction.
- Menu lines in which parameters can be changed are indicated by a preceding angle bracket (>). Pressing the upper or lower selection button moves this ">" pointer one line down or up.
Lines which cannot be jumped cannot be changed.

```
CAN'T
RECEIVE
ANY DATA
OK
```

- Changing a parameter
 - Push the ENT key.
 - Change the selected value with the selection buttons within the possible setting range.
 - Press the ENT key to accept the value.
 - Push the ESC key to come back to the exit position.
- If, instead of a submenu but the adjacent message appears, there is still no connection to a receiver. It is therefore necessary to switch on the receiving system or, if necessary, to bind the receiver again if the latter is not the "last bound".

SETTING & DATA VIEW



Note

The description of the menus summarized in this collective concept is based on the characteristics of the HoTT standard receivers and therefore applies only to them.

```
TELEMETRY
▶SETTING & DATA VIEW
SENSOR
RF STATUS DISPLAY
SELECT ANNOUNCE
RX DATA ON
ALARM SETTING
```

Special receivers, e.g. the receivers GR-18 HoTT (No. 33579) or Falcon 12 (No. S1035) are equipped with unique versions of the menu "SETTING & DATA VIEW". Corresponding menu descriptions are contained in their respective receiver instructions.

The remaining points of the "telemetry" menu as well as the "display telemetry data" described in the following section are generally valid and thus apply equally to all receivers.

RX DATAVIEW

```
RX DATAVIEW V6.37 >
S-QUA100% S-dBM-030dBm
S-STR100% R-TEM.+28°C
L PACK TIME 00010msec
R-VOLT :05.0V
L.R-VOLT:04.5V
SENSOR1 :00.0V 00°C
SENSOR2 :00.0V 00°C
```

In this display page of the submenu "SETTING & DATA VIEW" you will not be able to make any settings. This page is for information only:

Value	Description
Vx.xx	Firmware version of the receiver
S-QUA	Quality expressed as a percentage of the signal packages from the transmitter arriving at the receiver
S-dBm	Level in dBm expressed as the percentage of the transmitter signal arriving at the receiver
S-STR	Signal strength expressed in percentage of the signal from the transmitter arriving at the receiver
R-TEM.	Receiver temperature in °C
L PACK TIME	Shows the longest time in milliseconds in which data packages were lost when transmitting from the transmitter to receiver
R-VOLT	Current operating voltage of the receiver

L.R-VOLT	Current operating voltage of the receiver since the last time the receiver was turned on
SENSOR1	Indicates the voltage and °C of the optional telemetry sensor
SENSOR2	Indicates the voltage and °C of the optional telemetry sensor 2

S-QUA **(Signal quality)**

This value is a type of evaluation of usefulness, expressed as a percentage, of the signal packages from the transmitter arriving at the receiver.

This evaluation in percentage of the quality of the signal packages from the transmitter received by the receiver's microprocessor is shown live on the transmitter's display via the receiver's feedback channel.

S-dBm **(reception level)**

dBm is a logarithmic value that provides a comparative overview of extreme differences in level. A level of 0dBm corresponds to 1mW. The dBm is positive for an output > 1mW, and the dBm is correspondingly negative for an output < 1mW.

In practice, this means that when a remote control system is used, generally (significantly) less than 1 mW and hence a level < 0dBm is received by the receiver from a 100 mW output of a standard transmitter (= 20dBm) because of the fanning out of the radio waves and associated weakening of the signal on the way to the receiver. Consequently, the reception shown in dBm in the display is generally negative. The higher the number after the minus sign, the worse the reception. This is important to remember during range tests before using the model.

The range must be at least 50 m in an activated range test. At this distance, a value not worse than -80 dBm may be displayed in the "RX DATAVIEW" display under "S-dBm" to ensure safe operation. If the value is lower, such as -85 dBm, the model should not be put into operation, but the installation of the receiving system and the position of the antennas should be checked.

During operation, the reception should not fall below -90dBm; if this is the case, you should reduce your distance to the model. Normally before this level is reached, the acoustic range warning is triggered (one beep every second) which reflects the signal strength of the feedback channel to ensure safe operation.

S-STR (signal strength)

The signal strength (S-STR) is displayed in percentage. In general, an acoustic range warning (1 beep every second) is emitted once the receiver signal in the feedback channel becomes too weak. Since the transmitter's output is significantly higher than the receiver, the model can always be operated safely. The model distance should nevertheless be reduced for reasons of safety until the warning tone stops.

R-TEM. (receiver temperature)

The receiver temperature threshold which triggers a warning can be set in the submenu "RX SERVO TEST" under "ALARM TEMP+" (50 ... 80°C) and "ALARM TEMP-" (-20 ... +10°C). When the temperature is too high or too low, a continuous warning tone sounds, and "TEMP.E" appears in red at the top right in the receiver menu "RX". In the "RX DATAVIEW" display, the parameter "R-VOLT" is displayed inverted.

The standard operating range is between -10 and +55 ° C.

L PACK TIME (data packages)

This indicates the longest period in milliseconds in which data packages are lost when transmitted from the transmitter to receiver. Only when this period exceeds the "delay time" selected under "Fail-Safe", the receiver falls into the fail-safe mode for the remaining duration of the interference.

R-VOLT (actual receiver operating voltage)

Display of the current operating voltage of the receiver. This value is also shown in the base display of the transmitter.

L.R-VOLT (lowest receiver operating voltage)

"L.R-VOLT" shows the lowest operating voltage of the receiver since the last time the receiver was turned on.

If this voltage differs significantly from the current operating voltage "R-VOLT", the drain on the receiver battery from the servos may be too much and/or the resistance of the wiring is too high. In this case, check and correct your power supply to maximize operating safety.

Sensors 1 + 2

Indicates the voltage and temperature in °C of the optional sensors 1 and 2.

6CH FUNCTION



Note

This function affects only receivers GR-12 and GR-16: Depending on the status of these two receivers, the two previously described lines "SENSOR 1 + 2" are replaced by the line "6CH FUNCTION".

```

RX DATAVIEW V6.39 >
S-QUA100%S-dBM-030dBm
S-STR100% R-TEM.+28°C
L PACK TIME 00010msec
R-VOLT :05.0V
L.R-VOLT:04.5V

```

6CH FUNCTION:SERVO

Depending on the firmware status and the function selected in the line "6CH FUNCTION", the connection 6 of the receivers GR-12 and GR-16 can be used to connect RC components or a circuit for voltage measurement:

- SERVO

The connection 6 is suitable for the operation of RC components.

- BATT V

After switching as described before, a DC voltage off max. 25,5 V can be displayed instead of the receiver voltage. This way it is possible to monitor the main battery voltage without using external sensors. The ESCs S3082 and S3083 have this switch already included.

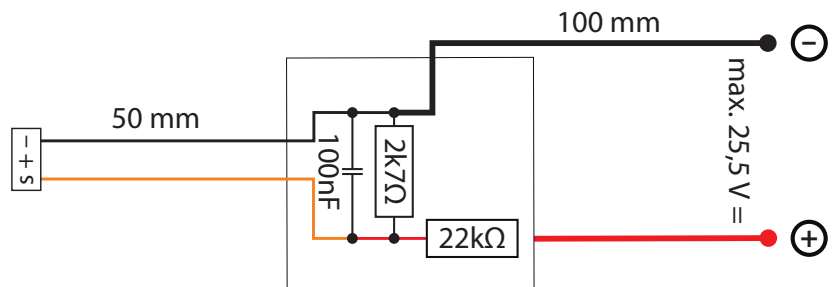

Attention

Never connect a power supply with an output voltage higher than 8,4 V directly to a connection port of the receiver! The receiver and all connected devices would be immediately destroyed.

RX SERVO

```

RX SERVO V6.37 <>
>OUTPUT CH: 01
REVERSE : OFF
CENTER : 1500µsec
TRIM : -000µsec
LIMIT- : 150%
LIMIT+ : 150%
PERIOD : 20msec

```

Value	Description	Possible settings
Vx.xx	Firmware version of the receiver	None
OUTPUT CH	Selected channel	1 ... depending on the receiver
REVERSE	Servo reversal	ON/OFF
CENTER	Servo center in µs	Currently set "servo neutral position"
TRIM	Trim position in µs deviation from the CENTER position	-120 ... +120µs
LIMIT-	Limit on the "-" side of the servo travel in percentage servo travel	30 ... 150%

Value	Description	Possible settings
LIMIT+	Limit on the "+" side of the servo travel in percentage servo travel	30 ... 150%
PERIOD	Cycle time in ms	10 or 20ms

OUTPUT CH **(selected channel)**

In this line, select the OUTPUT CH to be set (receiver servo connection).

Programming step-by-step

1. Select the line "OUTPUT CH" using the selection keys.
2. Push the ENT key.
The value field is displayed inverted:
3. Use the selection keys to set the desired receiver output.
4. Proceed in the same way with the remaining channels.

Reverse **(servo reverse)**

When the value field is active, this sets the direction of rotation of the servo connected to the selected control channel:

Servo Reverse ON / OFF

CENTER **(servo center)**

In the "CENTER" line, the currently saved pulse time for the servo center of the control channel selected in the "OUTPUT CH" line is displayed in μs . The set channel pulse time of $1500 \mu\text{s}$ is the standard center position and hence the normal servo center.

Programming step-by-step

1. Select the line "CENTER" using the selection keys.
2. Push the ENT key.
The value field is displayed inverted:
3. Move the corresponding control, control stick and/or trimming control into the desired position.
4. Push the ENT key.
The actual control position is saved as the new neutral position.

TRIM **(trimming position)**

In the "TRIM" line, the neutral position of the control channel selected in the "OUTPUT CH" line can be fine-tuned with the selection keys in $1 \mu\text{sec}$ steps:

The value in the line "CENTER" is set here of $\pm 120 \mu\text{s}$ around the TRIM value.

Factory setting: $0 \mu\text{s}$.

LIMIT-/+

(side-dependent limit -/+)

This option is for adjusting a side-dependent limit of the servo travel (rudder deflection) of the servo connected to the control channel selected in the "OUTPUT CH" line.

An adjustment within 30 ... 150% is performed separately for both directions.

Factory setting: 150%.

PERIOD

(cycle time)

In this line, specify the periods for the individual channel pulses. This setting is transferred for all control channels.

If your system is used exclusively with digital servos, you can set a cycle time (frame rate) of 10 ms.

If your system includes some or uses exclusively analogue servos, always select 20 ms since the analogue servos may be overloaded and respond by "jittering" or "growling".

RX FAIL SAFE

```
RX FAIL SAFE V6.37 <>
>OUTPUT CH: 01
INPUT CH: 01
MODE : HOLD
F.S.Pos. : 1500µsec
DELAY : 0.75sec
FAIL SAFE ALL: NO
POSITION : 1500µsec
```

The easiest and most recommendable way to make fail safe settings is to use the "Fail-Safe" menu that can be reached from the multi function list menu.

Furthermore, although a bit more involved, the "FAIL SAFE ALL" option described on the next page also works.

Beyond this is the relatively complex method of individual adjustments within the "RX FAIL SAFE" menu of the "Telemetry" menu using the options "MODE", "F.S.Pos." and "DELAY". The description of these versions starts with the "MODE" option below.

Value	Description	Possible settings
Vx.xx	Firmware version of the receiver	None
OUTPUT CH	Output channel (servo connection of the receiver)	1 ... depending on the receiver
INPUT CH	Input channel (control channel coming from the transmitter)	1 ... 16

MODE	Fail safe mode	HOLD FAIL SAFE OFF
F.S.POS.	Fail safe position	1000 ... 2000µs
DELAY	Reaction time	0.25, 0.50, 0.75 and 1.00s
FAIL SAFE ALL	Save the fail safe positions of all control channels	NO / SAVE
POSITION	Display the saved fail safe position	between approximately 1000 and 2000µs

OUTPUT CH (servo connection)

In this line, select the OUTPUT CH to be set (receiver servo connection).

Programming step-by-step

1. Select the desired line using the selection keys.
2. Push the ENT key.
The value field is displayed inverted:
3. Use the selection keys to set the desired value.
4. Proceed in the same way with the remaining channels.

INPUT CH (selected input channel)

The 12 control channels (INPUT CH) of the **mz-12 Pro HoTT** transmitter can be correspondingly administered by assigning the servo connection of the receiver selected in the OUTPUT CH line to the INPUT CH of another control channel by "channel mapping".

Select an input channel as described in "Programming step-by-step" under OUTPUT CH.



Note

It should be noted, however, that depending on the type of model, some control function acts on more than one control channel. If for example you entered "2AILE" in the basic settings for a model memory, the transmitter assigns control function 2 (aileron) to control channels 2+5 for the left and right aileron. The corresponding INPUT CH of the receiver to be mapped would in this case be channels 02 + 05.

MODE

(method)

The settings of the options "MODE", "F.S.Pos." and "DELAY" determine the response of the receiver when there is an interruption in transmission from the transmitter to receiver.

The setting programmed under "MODE" always refers to the channel set in the line OUTPUT CH.

The factory setting for all servos is "HOLD".

Each selected OUTPUT CH (servo connector of the receiver) can be set to:

- FAI(L) SAFE

With this selection, the corresponding servo moves into the position displayed in μs in the line "POSITION" in case of a malfunction after expiration of the delay set in the "DELAY" line for the remainder of the malfunction.

- HOLD

With the "HOLD" setting, over the course of a malfunction, the servo remains in the last correctly received servo position.

- OFF

With the "OFF" setting, over the course of a malfunction, the receiver stops transmitting (buffered) control pulses for the relevant servo output. The receiver switches off of the pulse line in a manner of speaking.



Attention

Analogue servos and many digital servos no longer experience resistance to the ongoing control pressure after control pulses stop and are moved out of their position at higher or lower speed.

F.S.POS.

(fail safe position)

For each OUTPUT CH (receiver servo connection), set the servo position for the servo to assume in a malfunction in "FAI(L) SAFE" in the line "F.S.POS." by using the + or – buttons.

The setting is carried out in steps of $10 \mu\text{s}$ as described below under "Programming step-by-step" under OUTPUT CH.

Factory setting: $1500 \mu\text{s}$ (servo center).

|| *In all three modes "OFF", "HOLD" and "FAI(L) SAFE", the function "F.S.POS." is particularly important when waiting for a valid signal after turning on the receiver:*

The servo immediately moves into the fail safe positions set in the "POSITION" line. This prevents landing gear from retracting when the receiver is accidentally turned on while the transmitter is off.

```
RX FAIL SAFE V6.37 <>
OUTPUT CH: 01
INPUT CH: 01
MODE      : HOLD
> F.S.Pos. : 1500µsec
DELAY     : 0.75sec
FAIL SAFE ALL: NO
POSITION  : 1500µsec
```

In normal model operation, the corresponding servo contrastingly acts according to the set "MODE" in a malfunction.

DELAY (fail safe reaction time or delay)

This line specifies how long the receiver is going to keep the RC components connected to it, after the connection has been terminated, at their most recently received positions before forwarding the previously stored fail-safe positions to the connected components. This setting is adopted by all the channels and only affects the servos programmed for "FAI(L) SAFE" mode.

The setting is carried out in steps of 0.25 s as described below under "Programming step-by-step" under OUTPUT CH.

Factory setting: 0.75 s.

FAIL SAFE ALL (global fail safe setting)

This submenu allows you to set the fail-safe positions of RC components with a "pushbutton" in a similarly simple way as the "Fail Safe" menu of the transmitter **mz-12 Pro HoTT**:

Programming step-by-step

```
RX FAIL SAFE V6.37 <>
OUTPUT CH: 01
INPUT CH: 01
MODE      : FAI-SAFE
F.S.POS.  : 1500µsec
DELAY     : 0.75sec
>FAIL SAFE ALL: SAVE
POSITION  : 1670µsec
```

1. Move to the line "FAIL SAFE ALL" by using the selection keys.
2. Push the ENT key to activate the value field.
"NO" is displayed inverted:
3. Use the upper or lower selection buttons to change the value field to "SAVE".
 - Use the transmitter control elements to **AT THE SAME TIME** move all the RC components, those that you have assigned in the "MODE" "FAIL SAFE" line and/or the others which have to take a specific position during the switch-on phase of the receiver system, to the desired fail-safe position and keep them still.
 - In the bottom "POSITION" line, the current servo position is displayed for the selected OUTPUT CH.
4. Push the ENT key.
 - The display in the value field changes again from "SAVE" to "NO".
 - This saves the positions of all of the RC components affected by these measures and simultaneously transfers them to the "F.S.Pos." line so that the receiver can access them in a malfunction.
5. You can now release the control elements of the transmitter.
6. Carefully switch off the transmitter and check the fail-safe positions on the basis of the servo positions.
7. Eventually repeat the process.

```
RX FAIL SAFE V6.37 <>
> OUTPUT CH: 04
  INPUT CH: 04
  MODE      : FAI-SAFE
  F.S.POS.  : 1500µsec
  DELAY     : 0.75sec
  FAIL SAFE ALL: NO
  POSITION   : 1500µsec
```

```
RX FAIL SAFE V6.37 <>
  OUTPUT CH: 06
> INPUT CH: 04
  MODE      : OFF
  F.S.POS.  : 1670µsec
  DELAY     : 0.75sec
  FAIL SAFE ALL: NO
  POSITION   : 1670µsec
```

```
RX FAIL SAFE V6.37 <>
  OUTPUT CH: 07
> INPUT CH: 04
  MODE      : OFF
  F.S.POS.  : 1230µsec
  DELAY     : 0.75sec
  FAIL SAFE ALL: NO
  POSITION   : 1670µsec
```

```
RX FAIL SAFE V6.37 <>
  OUTPUT CH: 08
> INPUT CH: 04
  MODE      : HOLD
  F.S.POS.  : 1770µsec
  DELAY     : 0.75sec
  FAIL SAFE ALL: NO
  POSITION   : 1670µsec
```

```
RX FAIL SAFE V6.37 <>
  OUTPUT CH: 04
> INPUT CH: 01
  MODE      : FAI-SAFE
  F.S.POS.  : 1500µsec
  DELAY     : 0.75sec
  FAIL SAFE ALL: NO
  POSITION   : 1500µsec
```

Fail safe in combination with channel mapping

To make sure that mapped servos react in the same way even in a malfunction, that is, RC components that are controlled by common control channel (INPUT CH), the corresponding settings of the INPUT CH determine the behaviour of mapped components.

If, for example, the servo connections 6, 7 and 8 of the 8-channel receiver GR-16 are mapped to one another by assigning the same control channel "04" to the OUTPUT CH (servo connections of the receiver) 06, 07 and 08 as INPUT CH, independently of the individual settings of the respective OUTPUT CH, of the INPUT CH 04, the fail-safe behaviour of these three RC components connected to the control channel 4 is determined. This is also true when INPUT CH 01 is used for mapping. In this case, servo connection 04 reacts according to the fail safe settings of CH 01.

The reaction time or delay set in the "DELAY" line contrastingly applies uniformly to all channels set to "FAI(L) SAFE".

RX FREE MIXER

```

RX FREE MIXERV6.37 <>
>MIXER : 1
MASTER CH : 00
SLAVE CH : 00
S-TRAVEL- : 100
S-TRAVEL+ : 100
RX WING MIXER
TAIL TYPE : NORMAL
    
```

Up to five mixers can be programmed in the receiver.

Value	Description	Possible settings
Vx.xx	Firmware version of the receiver	None
MIXER	Mixer selection	1 ... 5
MASTER CH	Signal source or source channel	0, 1 ... according to the receiver
SLAVE CH	Target channel	0, 1 ... depending on the receiver
S-TRAVEL-	Mixing on the "-" side of the servo travel in percentage servo travel	0 ... 100%
S-TRAVEL+	Mixing on the "+" side of the servo travel in percentage servo travel	0 ... 100%
RX WING MIXER TAIL TYPE	Tail type	NORMAL, V-TAIL (V-LW) ELEVON (elevator/aileron mixer for delta and flying wing)

MIXER



Note

If mixing functions have already been programmed or planned in the "Mixer" or "Free Mixer" menu, it is imperative that these mixers do not overlap with those of the "RX FREE MIXER" menu!

MASTER CH

("from")

According to the same principles described in the section "free mixer", the signal at MASTER CH (signal source or source channel) can be mixed with the SLAVE CH (target channel) to the adjustable amount.

The default setting "00" must be selected or left if no mixer is to be set.

SLAVE CH

("to")

The signal of the MASTER CH (signal source or source channel) is proportionately mixed with the SLAVE CH (target channel). The level of mixing is determined by the percentages entered in the "TRAVEL-" and "TRAVEL+" lines.

The default setting "00" must be selected or left if no mixer is to be set.

TRAVEL-/+ **(level of mixing in %)**

With the settings of these two lines, the percentage of mixing is specified in relation to the MASTER signal separately for both directions.

Programming step-by-step

1. Push the ENT key.
2. Set the desired mixer 1 ... 5 through the selection keys.

|| *The following settings in this display only relate to the mixers selected in the "MIXER" line:*

3. Use the selection keys to move to the MASTER CH line.
4. Push the ENT key.
5. Set the desired MASTER CHANNEL (source channel) through the selection keys.
6. Push the ENT key.
7. Set the desired SLAVE CHANNEL (target channel) through the selection keys.
8. Push the ENT key.
9. Use the selection keys to move to the S-TRAVEL- and/or S-TRAVEL+ line.
10. Push the ENT key.
11. Use the selection keys to set the desired value.
12. Press the ENT key to complete the operation.



RX WING MIXER TAIL TYPE **(tail type)**



Note

The types of tail described below are also available in the line "Tail" of the sub-menu "Model type" and should preferably be specified there. In this case, the default "NORMAL" must always be left in the line "TAIL TYPE".

NORMAL

This setting corresponds to the classic airplane type with a rear tail and separate rudder and elevator. No mixing function is required for this model type.

V-TAIL

With this model type, the control functions of the elevator and rudder are linked to each other so that each of the two tail flaps assumes the elevator and rudder function controlled by a separate servo.

The servos are normally connected to the receiver as follows:

OUTPUT CH 3: V-tail servo, left

OUTPUT CH 4: V-tail servo, right

Observe the instructions in the receiver section, if the control surface deflections should not follow the control commands.

ELEVON (delta/flying wing models)

The servos connected to outputs 2 and 3 assume an aileron and elevator function. The servos are normally connected to the receiver as follows:

OUTPUT CH 2: Aileron/elevator, left

OUTPUT CH 3: Aileron/elevator, right

Observe the instructions in the receiver section, if the control surface deflections should not follow the control commands.

RX CURVE



```

RX CURVE      V6.37 <>
>CURVE1 CH   : 02
   TYPE      : B
CURVE2 CH   : 03
   TYPE      : B
CURVE3 CH   : 04
   TYPE      : B
    
```

With the RX CURVE option, you can administer control characteristics for up to three servos:

Value	Description	Possible settings
Vx.xx	Firmware version of the receiver	None
CURVE1, 2 or 3 CH	Channel assignment of the respective curve setting	1 ... depending on the receiver
TYPE	Curve type	A, B, C see figure

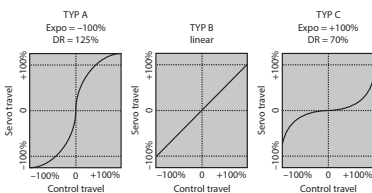

A non-linear control function is used, if necessary, for the control functions 2, 3 and 4. These channel presets also correspond to the factory setting.

It should be noted, however, that depending on the type of model, some control function acts on more than one control channel. When, for example, in fixed-wing model in the transmitter is preset "2AI" and instead of the individually adjustable menu "D / R Expo" of the transmitter **mz-12 Pro HoTT** the RX CURVE option should be used, by setting 2 curves. Otherwise, the left and right aileron have different control characteristics.

```

RX CURVE      V3.67 <>
>CURVE1 CH   : 02
   TYPE      : A
CURVE2 CH   : 05
   TYPE      : A
CURVE3 CH   : 04
   TYPE      : B
    
```

CURVE 1, 2 or 3 CH

Select the desired control channel (INPUT CH).

The following setting in TYPE only affects the selected channel.

TYPE

Select the desired control curve:

A EXPO = -100% and DUAL RATE = 125%

The servo reacts strongly to control stick movement around the neutral position. The curve becomes flatter as the rudder deflection increases to about 125% of the servo travel.

B Linear setting.

The Servo follows the control stick travel in a linear manner in case of not changed servo travel.

C EXPO = +100% and DUAL RATE = 70%

The servo reacts weakly to control stick movement around the neutral position. The curve becomes steeper as the rudder deflection reduces to about 70% of the servo travel.

5CH FUNCTION: "SERVO" or "SENSOR"

```

RX CURVE      V3.70 <>
> CURVE1 CH   : 02
   TYPE       : B
  CURVE2 CH   : 05
   TYPE       : B
  CURVE3 CH   : 04
   TYPE       : B
5CH FUNCTION : SERVO
    
```



With certain receivers, a certain servo connection is designed to be switchable instead of an independent telemetry connection. Thus, for example, not only the adapter cable (No. 7168.6S) for updating the receiver but also a telemetry sensor can be connected to the receiver GR-12L on the servo connection 5, which is marked with an additional "T".

In order for the connected device to be correctly identified by the receiver, servo connection 5 needs to be switched from "SERVO" to "SENSOR" and vice versa.

```

RX CURVE      V3.70 <>
  CURVE1 CH   : 02
   TYPE       : B
  CURVE2 CH   : 05
   TYPE       : B
  CURVE3 CH   : 04
   TYPE       : B
> 5CH FUNCTION : SERVO
    
```

Programming step-by-step

1. Use the lower selection key to move the symbol ">" on the left margin in front of the lowest line.
2. Push the ENT key.
The selection field is displayed inverted.
3. Use one of the selection buttons to select the desired setting, for example "SENSOR".
4. Push the ENT key.
5. Push with correspondingly frequency the ESC key to return to the basic display of the transmitter.

RX SERVO TEST

```

RX SERVO TESTV6.37 <
ALL-MAX : 2000µsec
ALL-MIN : 1000µsec
>TEST : STOP
ALARM VOLT : 3.8V
ALARM TEMP+: 55°C
ALARM TEMP-: -10°C
CH OUTPUT TYPE:ONCE
    
```

In this menu, you can use the RX SERVO TEST function to test the servos connected to the currently active receiver, set voltage and temperature limits, and influence the signal output.

Value	Description	Possible settings
Vx.xx	Firmware version of the receiver	None
ALL-MAX	Servo travel on the "+" side for all servo outputs for the servo test	1500 ... 2000µs
ALL-MIN	Servo travel on the "-" side for all servo outputs for the servo test	1500 ... 1000µs
TEST	Test procedure	START / STOP
ALARM VOLT	Alarm threshold for the receiver's low voltage warning	3,0 ... 7,5V factory setting: 3,8V
ALARM TEMP+	Alarm threshold when the receiver temperature is too high	50 ... 80°C Factory setting: 55°C
ALARM TEMP-	Alarm threshold when the receiver temperature is too low	-20 ... +10°C Factory setting: -10°C
CH OUT-PUT TYPE	Channel sequence or type of aggregate symbol	ONCE, SAME, SUMI, SUMO and SUMD

Servo test function

ALL-MAX (servo travel on the "+" side)

In this line, set the maximum servo travel on the plus side of the control travel for the servo test.

2000µs corresponds to a full deflection on the "+" side of the servo travel, and 1500µs corresponds to the neutral position.

Make sure that the servos do not strike anything during the test routine.

ALL-MIN (servo travel on the "-" side)

In this line, set the maximum servo travel on the minus side of the control travel for the servo test.

1000µs corresponds to a full deflection on the "-" side of the servo travel, and 1500µs corresponds to the neutral position.

Make sure that the servos do not strike anything during the test routine.

TEST

(Start/Stop)

In this line, the servo test integrated into the receiver is started and stopped.

Servo test start step-by-step

1. Move to the line "TEST" by using the selection keys.
2. Push the ENT key.
The value field is displayed inverted:
3. Use one of the selection buttons to change the value field to "START".
4. Push the ENT key.
The servo test starts and the entry field returns to normal.

Servo test stop step-by-step

1. Push the ENT key.
The value field is displayed inverted:
2. Use one of the selection buttons to change the value field to "STOP".
3. Push the ENT key.
The servo test stops and the entry field returns to normal.

```
RX SERVO TESTV6.37 <
ALL-MAX : 2000µsec
ALL-MIN : 1000µsec
>TEST : STOP
ALARM VOLT : 3.8V
ALARM TEMP+ : 55°C
ALARM TEMP- : -10°C
CH OUTPUT TYPE:ONCE
```

```
RX SERVO TESTV6.37 <
ALL-MAX : 2000µsec
ALL-MIN : 1000µsec
TEST : STOP
>ALARM VOLT : 3.8V
ALARM TEMP+ : 55°C
ALARM TEMP- : -10°C
CH OUTPUT TYPE:ONCE
```

```
RX DATAVIEW VOLT.E >
S-QUA100%S-dBM-030dBm
S-STR100% R-TEM.+28°C
L PACK TIME 00010msec
R-VOLT : 03.7V
L.R-VOLT : 03.5V
SENSOR1 : 00.0V 00°C
SENSOR2 : 00.0V 00°C
```

```
RX SERVO TESTV6.37 <>
ALL-MAX : 2000µsec
ALL-MIN : 1000µsec
TEST : STOP
ALARM VOLT : 3.8V
>ALARM TEMP+ : 55°C
ALARM TEMP- : -10°C
CH OUTPUT TYPE:ONCE
```

ALARM VOLT

(receiver low voltage warning)

Through the "ALARM VOLT" the operating voltage of the receiver is monitored. The alarm threshold is adjustable between 3,0 and 7,5 Volt in 0,1 Volt steps. When the set limit value is exceeded, an audible signal (interval-beep long / short) is produced, and in all "RX ..." displays flashes "VOLT.E" in the upper right corner.

In the "RX DATAVIEW" display, the parameter "R-VOLT" is displayed inverted.

ALARM TEMP +/- (receiver temperature monitoring)

These two options monitor the receiver temperature. You can program a bottom threshold "ALARM TEMP-" (-20 ... +10°C) and an upper threshold "ALARM TEMP+" (+50 ... +80°C). If the upper or lower thresholds are exceeded, a continuous warning tone sounds, and "TEMP.E" appears inverted at the top right in all receiver displays. On the display page "RX DATAVIEW", the parameter "R-TEM" is also displayed inverted.

Make sure that the temperature of your receiver remains within the permissible range under all operating conditions (ideally between -10 and +55°C).

CH OUTPUT TYPE

(connection type)

In this line, select the type of servo control or alternately the signal type of the aggregate signal output.

ONCE

The servo connections of the receiver are actuated sequentially.

Recommended for analogue servos.

With this setting, the servos are automatically operated at a cycle of 20ms no matter what is set or displayed in the "RX SERVO" display in the line "PERIOD".

For the 12-channel receiver GR-24 (No. 33512) and the 16-channel receiver GR-32 (No. 33516) the value is 30 ms.

SAME

The servo connections of the receiver are actuated simultaneously in blocks. That is, the servos connected to connections 1 to 4 as well as 5 to 8 can be simultaneously supplied with their control signals with a GR-16 receiver (order No. 33508), and the servos connected to connections 1 to 4, 5 to 8 as well as 9 to 12 can be simultaneously supplied with their control signals with a GR-24 receiver (order No. 33512).

This is recommended for digital servos when several servos are used for a single function (such as an aileron) so that the servos are fully synchronized.

When exclusively digital servos are used, it is recommendable to set "10 ms" in the line "PERIOD" of the display "RX SERVO" to exploit the fast reaction of digital servos. When analogue servos or mixed operation is used, be sure to select "20 ms".



Attention

Selecting "SAME" always starts up to four servos at the same time, it is essential to ensure that the receiver power supply is adequately dimensioned.

SUMO

(aggregate signal OUT)

A HoTT receiver configured as SUMO always generates an aggregate signal from the control signals of all its controls channels, and forwards this to servo connection 8 of the GR-16 (No. 33508).

With receivers that have a two-digit number to the right of "SUMO" in their display, the active field switches to the right to channel selection after "SUMO" is confirmed. With the selection, you determine the highest control channels within the SUMO signal.

This presetting can be confirmed by pressing the ENT key again or by pressing the selection keys of one of the other channels between 04 and 16 and pressing the ENT key.

```
RX SERVO TESTV6.37 <
ALL-MAX : 2000µsec
ALL-MIN : 1000µsec
TEST : START
ALARM VOLT : 3.8V
ALARM TEMP+ : 55°C
ALARM TEMP- : -10°C
>CH OUT TYPE: ONCE
```

```
RX SERVO TESTV6.37 <
ALL-MAX : 2000µsec
ALL-MIN : 1000µsec
TEST : START
ALARM VOLT : 3.8V
ALARM TEMP+ : 55°C
ALARM TEMP- : -10°C
>CH OUT TYPE: SAME
```

```
RX SERVO TESTV6.37 <
ALL-MAX : 2000µsec
ALL-MIN : 1000µsec
TEST : START
ALARM VOLT : 3.8V
ALARM TEMP+ : 55°C
ALARM TEMP- : -10°C
>CH OUT TYPE: SUMO 08
```

The sum signals of the channel 1 ... X will be generated in a 20ms cycle (in the GR-24 and GR-32 receivers, 30ms) to the related output, also if on the "RX SERVO" display page in the "PERIOD" line 10ms has been set.

Primarily conceived for the satellite operation (described below) of two HoTT receivers, the aggregate signal that is generated by the receiver and defined as a SUMO can also be used to control a flybar system, providing that it has an appropriate input, or it can be used to control flight simulators by means of the adapter cable (No. 33310).

satellite mode

If in satellite use, two HoTT receivers are connected to each other by means of a three-wire connecting cable (order No. 33700.1 (300mm) or 33700.2 (100mm)) to servo connections for specific receiver types. Type GR-16 receivers (order No. 33508) and GR-24 (order No. 33512) are for example connected to each other at servo output 8. Further information can be found on the Internet at www.graupner.de.

By means of this connection, all of the channels selected in the "CH OUT TYPE" line of the HoTT receiver configured as a SUMO and identified as the satellite receiver are continuously transferred to the second HoTT ...

SUMI

(aggregate signal IN)

receiver (the main receiver) that needs to be programmed. The signal therefore always runs in the direction of the SUMI.

When reception fails, the receiver defined as SUMI only uses the aggregate signal coming from SUMO if at least 1 channel is programmed as fail safe in the SUMI.

If the reception fails of the receiver programmed as the SUMO satellite receiver, the servo(s) connected to this receiver assume the fail safe positions that are programmed in the satellite receiver independent of the main receiver.

If the reception fails for both receivers, then the fail safe settings of the SUMO are assumed in the receiver software current when these instructions were revised.



Attention

In individual cases, interactions may occur. It is therefore strongly recommended that relevant tests be performed before starting the model.

This receiver configuration is recommendable when for example one of the two receivers is installed in the model at a location with poor reception, or nozzles, carbon fiber material, etc. may weaken the reception depending on the flight direction which can restrict the range.

The most important control function should therefore be associated with the main receiver programmed as SUMI so that, in case of a malfunction, the model can still be controlled if the SUMO satellite receiver no longer receives a good signal.

Telemetry sensors must be connected to the satellite receiver (SUMO) and this is therefore to be bound "last" as a rule.

Each receiver should be connected to the common power supply with its own cable. With receivers subject to high current load, it may even be useful to connect them to the common power supply with two cables. If in contrast each of the two receivers are connected to their own power supply, the middle cable should be removed from one of the two plugs of the satellite cable (see figure).

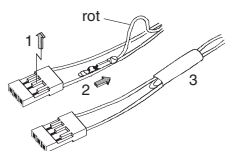

If you wish to do additional programming such as fail safe settings, disconnect the 3-pin satellite connection between the two receivers, and only turn on the relevant receiver. You may also have to change the binding sequence.

SUMD

(digital sum signal)

A HoTT receiver configured as SUMD as described earlier always generates a digital aggregate signal from the control signals of a selectable number of its controls channels, and forwards this to servo connection 8 in the GR-16 (No. 33508) and GR-24 (No. 33512) receivers.

At the time this manual was revised, this type of signal was being used by several of the latest electronic applications of flybarless systems, power supplies, etc.



Attention

You therefore need to consult your setting instructions for the attached device since otherwise you may make it impossible to fly the model.

```
RX SERVO TESTV6.37 <
ALL-MAX : 2000µsec
ALL-MIN : 1000µsec
TEST : START
ALARM VOLT : 3.8V
ALARM TEMP+ : 55°C
ALARM TEMP- : -10°C
>CH OUT TYPE: SUMDHD12
```

After confirming "SUMD" by pushing the ENT button at the bottom right in the display, the active value field switches to the right for selecting one of the three possible receiver reactions in case of a loss of reception (fail safe):

```

RX SERVO TESTV6.37 <
ALL-MAX : 2000µsec
ALL-MIN : 1000µsec
TEST : START
ALARM VOLT : 3.8V
ALARM TEMP+ : 55°C
ALARM TEMP- : -10°C
>CH OUT TYPE:SUMDHD12

```

- HD ("hold")
The last signals recognized as being correct are retained at the output (hold).
- FS (fail safe)
The data of previously-saved fail safe positions are provided at the output.
- OF (OFF)
No signals are supplied for the duration of the loss of reception.



Attention

Analogue servos and many digital servos no longer experience resistance to the ongoing control pressure after control pulses stop and are moved out of their position at greater or lesser speed.

```

RX SERVO TESTV6.37 <
ALL-MAX : 2000µsec
ALL-MIN : 1000µsec
TEST : START
ALARM VOLT : 3.8V
ALARM TEMP+ : 55°C
ALARM TEMP- : -10°C
>CH OUT TYPE:SUMDHD12

```

Finally, switch the active field to channel selection by pushing the ENT button at the bottom right. With the selection, you determine the highest control channels within the SUMD signal. Normally, a value greater than "12" is not required by potentially connectable devices.

SETTINGS & DISPLAYS sensor(s)

```

RX SERVO TESTV6.37 <>
>ALL-MAX : 2000µsec
ALL-MIN : 1000µsec
TEST : STOP
ALARM VOLT : 3.8V
ALARM TEMP+ : 55°C
ALARM TEMP- : -10°C
CH OUTPUT TYPE:ONCE

```

If one or more sensors are connected to a receiver and a telemetry link exists with this receiver, you can retrieve the display of any sensor and change its settings after the display "RX SERVO TEST" described above.

On the last page of the receiver ("RX SERVOTEST"), in this case, a "<" pointing to the left should also be visible in the upper right-hand corner of the left-hand pointing bracket ">" as a sign that further screens can be changed.

Switch between the modules step-by-step

1. Push simultaneously the left and the right selection keys.
The selection window shown on the left is displayed.
2. The desired line can be selected in a rotation order through the upper and lower selection keys.
3. This selection can be confirmed immediately after pressing the ENT key or simply waiting until the selection screen is automatically blanked out after a short time.



Note

If you have connected at least one sensor to your telemetry receiver and it has firmware from the same Vx firmware package as your receiver, you can switch directly between the individual modules.

If, on the other hand, a sensor uses a firmware from an older firmware package than the one used in the receiver, it may be necessary to select "etc." instead of the direct selection of the sensor.

4. Use the right selection button to change to the displays of the selected device and to change these settings or to change the settings as described in the instructions supplied with the device.

SENSOR

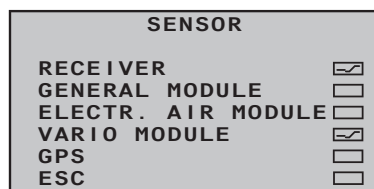
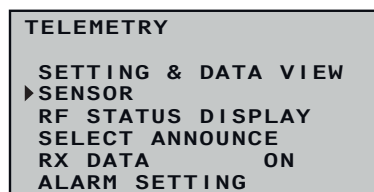

If a sensor or several sensors have been connected to the receiver before the receiver is switched on, the transmitter **mz-12 Pro HoTT** detects this automatically in the course of setting up the telemetry connection.

After selecting the desired menu line, pressing the SET key opens the selected submenu.

Active () or inactive () sensors are automatically labelled in this submenu provided that a telemetry link exists. Manual sensor selection is then unnecessary and impossible.

The corresponding graphic displays are activated automatically and the corresponding setting pages can be selected accordingly in the "SETTING & DATA VIEW" submenu described above.

Display of RF status

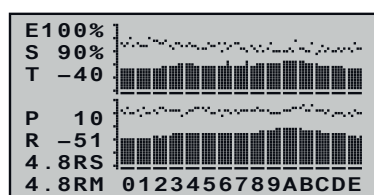
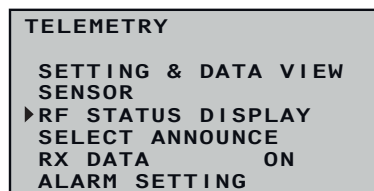

After selecting the desired menu line, pressing the SET key opens the selected submenu. This visualises the quality of the connection between transmitter and receiver.

- Upper row
Level of channels 1 ... 75 coming from the receiver of the 2.4 GHz band in dBm at the transmitter.
- Lower row
Level of channels 1 ... 75 coming from the transmitter of the 2.4 GHz band in dBm at the receiver.

Note

- The height of the bar is a measure of the reception level expressed as logarithmic values with the unit dBm (1 mW = 0dBm).
- 0dBm corresponds to the two baselines in the above graph. Consequently, the level is poorer the higher the bar and vice versa, see also "S-dBm (reception level)" in the section "RX DATAVIEW".
- The points over the bar mark the worst reception levels since the transmitter was switched on or the display was reset by pressing the transmitter's left and right selection buttons (CLEAR) at the same time.

- In addition to the graphic display of the reception level, additional numeric information is provided to the left. This means:

Value	Description
E	Quality expressed as a percentage of the signal packages from the receiver arriving at the transmitter
S	Quality expressed as a percentage of the signal packages from the transmitter arriving at the receiver
T	Level in dBm expressed as the percentage of the receiver signal arriving at the transmitter
P	Shows the longest time in milliseconds in which data packages were lost when transmitting from the transmitter to receiver
R	Level in dBm expressed as the percentage of the transmitter signal arriving at the receiver
RS	Current operating voltage of the receiver
RM	"L.R-VOLT" shows the lowest operating voltage of the receiver since the last time the receiver was turned on.

SELECT ANNOUNCE

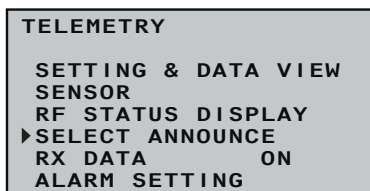

After selecting the desired menu line, pressing the SET key opens the selected submenu. In this, the announcements to be selected can be individually activated and deactivated and the type of replay can be selected.

REPEAT

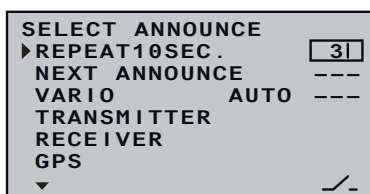

In order to start the announce output via the headphone connection, at least in the line "REPEAT" a switch has to be assigned as described in the section "Control, switch and transmitter switch assignment".

As long as the selected switch is active, the last reproduced message will be repeated in the period which has been set on the left side of the switch.

Simultaneously pressing the left and right selection keys (CLEAR) resets the time setting to "1 sec"

NEXT ANNOUNCE

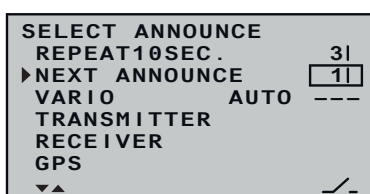

With a switch assigned to this line, preferably the S2 pushbutton, you incrementally switch in a loop between the options (described below) "TRANSMITTER", "RECEIVER", and voice triggers selected under "Sensors".

As long as the switches assigned to the line "REPEAT" and "TRIGGER" are switched on, the selected announces will be repeated in the adjusted interval.

VARIO

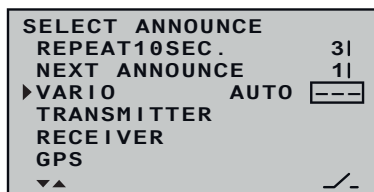

In order to be able to start outputting Vario tones via the headphone jack, this line must be assigned a switch.

If there are several Vario sensors in the model, for example a General Electric and a GPS module, the Vario sensor, which determines the output of the varios, can be selected:

The following selections are available: VARIO, GAM, EAM, GPS so as AUTO. (Following this sequence, the first of the sensors connected to the receiver is selected as the "main" in the "Auto" position.)

Transmitter

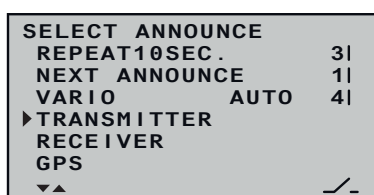

After selecting the desired menu line, pressing the selection keys and the SET key opens the selected submenu.

Programming step-by-step

1. Select the desired line using the selection keys.
2. Push the ENT button to switch between (ON) and (OFF).
3. Proceed in the same way with the remaining lines.

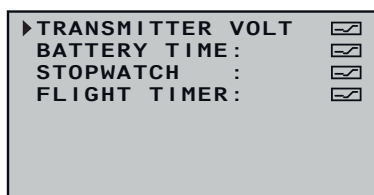

RECEIVER

The receiver voice triggers are selected as described above.

"Sensors"

The names of sensors are only displayed line-by-line if the sensors connected to the receiver are detected automatically when the RC system is switched on.

Three corresponding voice triggers are selected as described above.

Telemetry data display

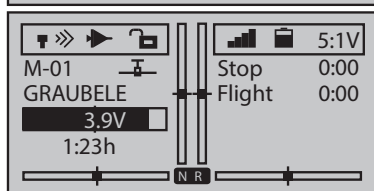
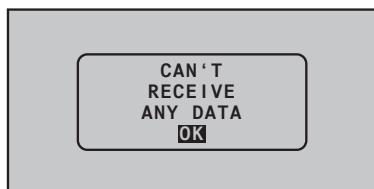
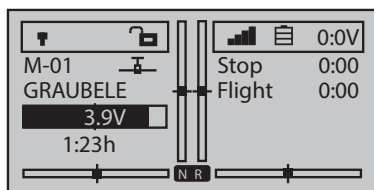

The display of the **mz-12 HoTT Pro** transmitter is used for operating the transmitter and to graphically display telemetry data. The change between these two use mode is carried out in the main display by pushing one of the two selection keys of the left four way keys.

If, instead of the expected display, the adjacent message appears, no receiver is within range which can respond to the telemetry link. Turn on your receiver, or bind a receiver to the active model memory.

Switch between basic display and telemetry displays

As long as there is a telemetry connection to the receiver and the basic display is active in the display of the transmitter, pressing any selection key switches the display of the telemetry displays and returns to the basic display by pressing the ESC key.

After recalling the telemetry display, the "receiver" display is shown as a standard, the more detailed description can be found in the section with the same name.

Sensors

Any combination of to four sensors can be connected to a receiver that operates by telemetry. The data from the sensors are transmitted to the graphs described below only if they are properly connected to the receiver before the receiver is turned on and after they recognized by the transmitter.

In addition, sensors in the submenu "SETTINGS & DATA VIEW" of the "Telemetry" menu will only respond under the above prerequisite corresponding to the instructions for the respective sensor.

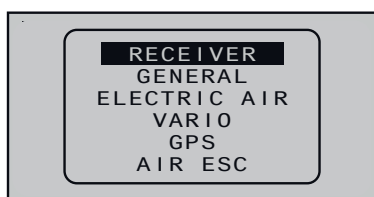

Switch between the modules step-by-step

1. Push simultaneously the upper and the lower selection keys.
A list of selectable telemetry modules is displayed.
2. Select the desired line using the upper and the lower selection keys.

|| If no sensor is activated, all further telemetry modules are excluded from the selection list, with the exception of the "RECEIVER" display described below.
3. The selected module can either be confirmed immediately with the ENT key or you can simply wait until the desired display is automatically displayed after a short time.
4. Pressing the left or right selection button changes between the displays of the selected sensor.
5. To return to the basic display, press the ESC key.

To find out more about the modules described below, go to www.graupner.de at the respective product.

RECEIVER

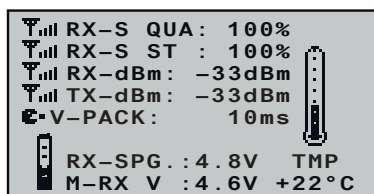

This display offers a graph of the data from the display "RX DATA-VIEW" of the "Telemetry" menu "SETTINGS, DISPLAYS, .

It have the following meanings:

Value*	Description
RX-S QUA	Quality expressed as a percentage of the signal packages from the transmitter arriving at the receiver
RX-S ST	Signal strength expressed in percentage of the signal from the transmitter arriving at the receiver
RX-dBm	Level in dBm expressed as the percentage of the transmitter signal arriving at the receiver
TX-dBm	Level in dBm expressed as the percentage of the receiver signal arriving at the transmitter
V PACK	Shows the longest time in ms in which the data packets are lost during a transmission from the transmitter to receiver
RX-VOLT	Current operating voltage of the receiver power supply in Volts
M-RX V	Lowest operating voltage of the receiver power supply since the last startup in Volts
TMP	The thermometer visualizes the current operating temperature of the receiver

* Detailed explanations of the terms in the "Value" column can be found in the further section "RX DATA VIEW".

General module

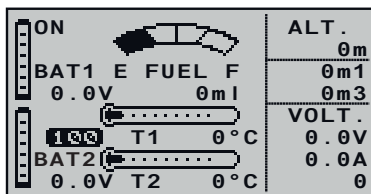
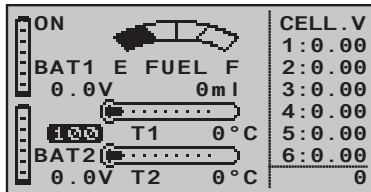

These two displays visualize the data of a general engine module (No. 33610) or a general air module (No. 33611) that may be connected to the receiver.

Depending on the configuration of the modules with additional sensors, the following data can be permanently shown on the display:

At the upper edge to the left the switching state of the current control as well as a level indicator of the fuel tank to the right. To the right, the fuel quantity consumed in the current switch-on period is in ml.

The two graphics down to the left show the current voltage measured by the temperature and voltage sensors (No. 33612 and 33613) connected to the model from up to two batteries (BAT-1 and BAT-2). They also show the corresponding temperature on the right: On the left side, you can see the data of sensor 1 and on the right side, you can see the data of sensor 2.

The inverse display between "BAT1" and "BAT2" visualizes the quality of the incoming signal from the transmitter in%.

On the right-hand side, either a list of the current cell voltages of an up to six-cell LiPo battery or the actual altitude relative to the location is displayed alternately. The rise or fall in m / 1 s and m / 3 s, the actual current in amperes and the actual voltage of the batteries connected to the battery connection of the module.

It have the following meanings:

Value	Description
ON	Current control ON
BAT1/BAT2	BATT 1 and BATT 2
100	Signal quality in % (RX-S QUA)
FUEL	Fuel level/tank display
E / F	Empty / Full
ml	Fuel quantity consumed in ml
T1 / T2	Temperature of sensors 1 and 2
CELL.V	Cell voltage of cells 1... 6
ALT	Current altitude (only with module 33611)
Om1	Ascent/descent in m/1s (only with model 33611)
Om3	Ascent/descent in m/3s (only with model 33611)
V	Actual voltage of the drive battery
A	Momentary current in amps

Microcopter display



This display shows the data of a HoTT-compatible microcopter. The abbreviations have the following meaning (from top to bottom starting on the left):

Value	Description
V	Current voltage
0:00	Time turned on
mAh	Used battery charge since the device has been turned on
0	Position number of the satellite
km/h	Speed above ground calculated by the GPS system
Alt	Current altitude
Dir	Direction of movement
I	Momentary current
m	Distance from the starting location calculated by the GPS system
°	Position in angular degrees relative to the starting location calculated by the GPS system

Messages from the microcopter sensor are displayed in the bottom line in the above display.

Battery and consumption display

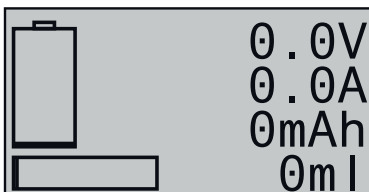

This display visualizes the current voltage, the currently flowing current and the capacity consumed within the current switch-on period from the battery connected to the General Engine (No. 33610) or General-Air module (No. 33611) and at the lower edge the fuel consumption (in ml) registered by the fuel sensor (No. 33614), if applicable.

SENSOR 1 and SENSOR 2

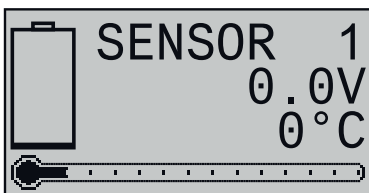

These two displays visualize, if necessary, the connection to "T (EMP) 1" and / or "T (EMP) 2" of the General Engine (No. 33610) or General Air module (No. 33611) connected to the temperature / voltage sensors (No. 33612 or 33613).

RPM sensor

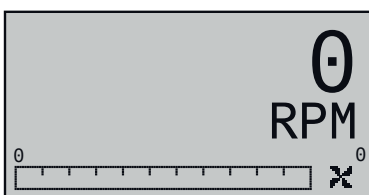

This display visualizes the speed sensor (No. 33615 or 33616), which may be connected to a General Engine (No. 33610) or General Air Module (No. 33611) measured speed.



Note

To correctly display the RPM, the relevant number of blades and the charge must be entered beforehand in the "Telemetry" menu.

Vario



This display shows the data about altitude in meters related to launch so as the the current climb/sink rate in m/s, from the vario integrated in the General Air Module (No. 33611) .

Speed display

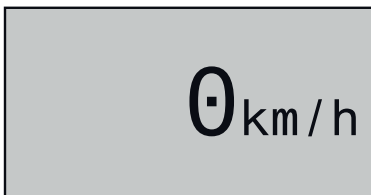

In base on the related sensors this display shows the current speed on the ground.

Air pressure display



In base on the related sensors this display shows the current air pressure.

"lowest cell"



According to the availability of the corresponding sensor, this display shows the currently lowest cell voltage of a battery pack as well as the number of the relevant cell.

ELECTRIC AIR MODULE



These two displays visualize the data of an Electric Air Module connected to the receiver (No. 33620).

Depending on the configuration of the module with additional sensors, the following data can be permanently shown on the display:

The current voltage of the power source connected to the battery connector of the module and its currently flowing current are shown on the upper left of the current state.

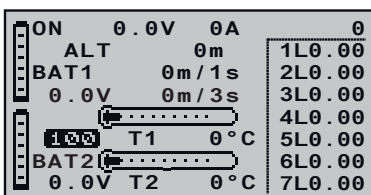

In the middle, the current altitude relative to the site, the rise or fall of the model in m / 1 s and m / 3 s, and the temperature / voltage sensors connected to the module (No. 33612 or 33613) measured current voltages of up to two accumulators (BAT1 and BAT2). In the middle below the associated temperatures.

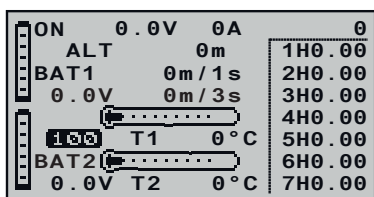

The inverse display between "BAT1" and "BAT2" visualizes the quality of the incoming signal from the transmitter in%.

The current cell voltages of the maximum 7-cell battery packs connected to the balancer connection 1 (L) and / or 2 (H) are alternately shown on the right-hand edge.

It have the following meanings:

Value	Description
ON	Current control ON
V	Current voltage
A	Momentary current
BAT1/BAT2	BATT 1 and BATT 2
ALT	Current altitude
m/1s	Ascent/descent in m/1s
m/3s	Ascent/descent in m/3s
100	Signal quality in % (RX-S QUA)
T1 / T2	Temperature of sensors 1 and 2
L or H	Cell voltage of cells 1... 14 L = Balance port 1 H = Balance port 2

Microcopter display

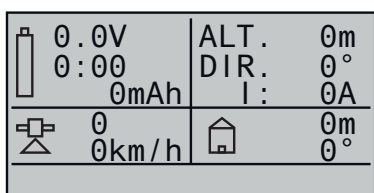

This display shows the data of a HoTT-compatible microcopter. The abbreviations have the following meaning (from top to bottom starting on the left):

Value	Description
V	Current voltage
0:00	Time turned on
mAh	Used battery charge since the device has been turned on
0	Position number of the satellite
km/h	Speed above ground calculated by the GPS system
Alt	Current altitude
Dir	Direction of movement
I	Momentary current
m	Distance from the starting location calculated by the GPS system
°	Position in angular degrees relative to the starting location calculated by the GPS system

Messages from the microcopter sensor are displayed in the bottom line in the above display.

BAT



This display visualizes the current voltage, the currently flowing current and the capacity consumed within the current switch-on period from the battery connected to the Electric Air Module (No. 33620).

SENSOR 1 and SENSOR 2

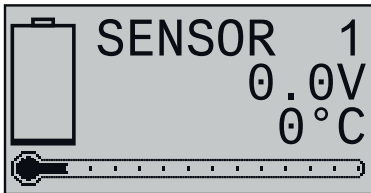

These two displays visualize, if necessary, the connection to "T (EMP) 1" and / or "T (EMP) 2" of the Electric Air module (No. 33620) connected to the temperature / voltage sensors (No. 33612 or 33613).

Vario



This display shows the data about altitude in meters related to launch so as the the current climb/sink rate in m/s, from the vario integrated in the Electric Air Module (No. 33620) .

Speed display

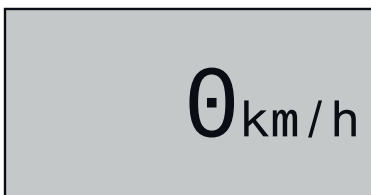

In base on the related sensors this display shows the current speed on the ground.

"lowest cell"



According to the availability of the corresponding sensor, this display shows the currently lowest cell voltage of a battery pack as well as the number of the relevant cell.

VARIO

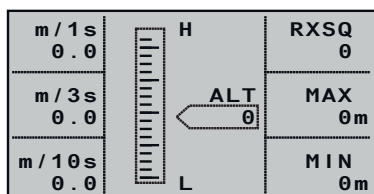

This display visualizes the data of a Vario module connected to the receiver (order No. 33601).

It have the following meanings:

Value	Description
ALT	Current altitude
RXSQ	Transmitter signal quality received by the receiver expressed as percentage.
MAX	preset altitude limit relative to the starting location, over which audible warning signals are output
MIN	preset maximum altitude below the starting point from which acoustic warning signals are issued
m/1s	Ascent/descent in m/1s
m/3s	Ascent/descent in m/3s
m/10s	Ascent/descent in m/10s

Microcopter display

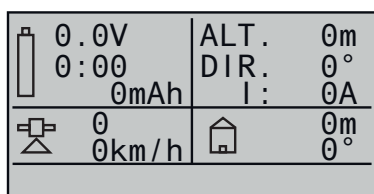

This display shows the data of a HoTT-compatible microcopter. The abbreviations have the following meaning (from top to bottom starting on the left):

Value	Description
V	Current voltage
0:00	Time turned on
mAh	Used battery charge since the device has been turned on
0	Position number of the satellite
km/h	Speed above ground calculated by the GPS system
Alt	Current altitude
Dir	Direction of movement
I	Momentary current
m	Distance from the starting location calculated by the GPS system
°	Position in angular degrees relative to the starting location calculated by the GPS system

Messages from the microcopter sensor are displayed in the bottom line in the above display.

Vario



This display shows the data about altitude in meters related to launch so as the the current climb/sink rate in m/s, from the connected vario.

Text displays



Depending on the availability of the corresponding sensors, text can be displayed with 2 x 10 or 3 x 7 characters in the following two displays.

GPS

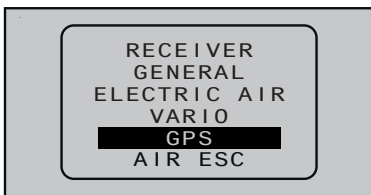

This display shows the data of a GPS module with an integrated Vario module connected to the receiver (No. 33600).

In addition to the current position data and model speed in the center of the display, the current height is displayed in relation to the starting location along with the ascent and descent of the module in m/1s and m/3s; the current reception as well as the distance from the starting location are also shown.



Note

As long as the two data fields are black on the lower right, no current GPS data is available.

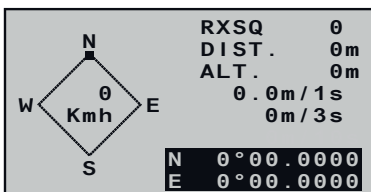

It have the following meanings:

Value	Description
W/N/E/S	West / North / East / South
Kmh	Speed over ground
RXSQ	Transmitter signal quality received by the receiver expressed as percentage.
DIST.	Distance
ALT	Current height relative to the starting location
m/1s	Ascent/descent in m/1s
m/3s	Ascent/descent in m/3s

Microcopter display





 0.0V	ALT. 0m
0:00	DIR. 0°
0mAh	I: 0A
 0	 0m
 0km/h	0°

This display shows the data of a HoTT-compatible microcopter. The abbreviations have the following meaning (from top to bottom starting on the left):

Value	Description
V	Current voltage
0:00	Time turned on
mAh	Used battery charge since the device has been turned on
0	Position number of the satellite
km/h	Speed above ground calculated by the GPS system
Alt	Current altitude
Dir	Direction of movement
I	Momentary current
m	Distance from the starting location calculated by the GPS system
°	Position in angular degrees relative to the starting location calculated by the GPS system

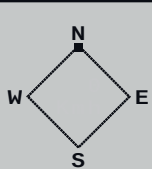
Messages from the microcopter sensor are displayed in the bottom line in the above display.

GPS

	 km/h
	 DIST
	 m/s
	 ALT.

This display shows the data of a GPS module with an integrated Vario module connected to the receiver (No. 33600).

It have the following meanings:

Value	Description
W/N/E/S	West / North / East / South
km/h	Speed over ground
DIST	horizontal distance in m
m/s	Ascent/descent in m/s
ALT	Height relative to the starting location in m

Vario

 m
 .  m/s

This display shows the data about altitude in meters related to launch or location so as the the current climb/sink rate in m/s, from the vario integrated in the GPS Module (No. 33600) .

Speed display



In base on the related sensors this display shows the current speed on the ground.

AIR ESC

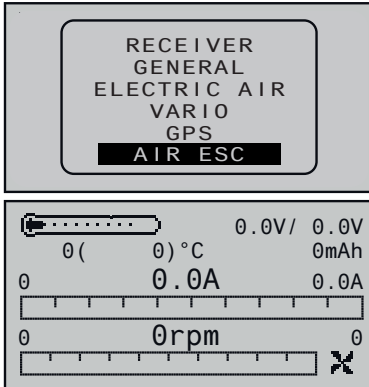

This display shows the data from a HoTT compatible brushless controller connected to the receiver with internal telemetry.

Regardless of possible controller values, the operating temperature and the maximum temperature of a telemetry-capable electric motor reached during the current switch-on period are visualized in the second line of the display.

The abbreviations have the following meaning (from top to bottom starting on the left):

Value	Description
V	Left value: current battery charge Right value: lowest battery level since the device has been switched on
°C	Left value: current controller temperature Value in brackets: maximum controller temperature since the device has been switched on
mAh	Used battery charge since the device has been turned on
A	Central and column indicators: actual current Right value: maximum current since the device has been switched on
rpm	Central and column indicators: rpm of the connected motor Right value: maximum rpm since the device has been switched on

Rpm indicator

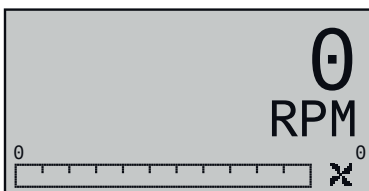

This indicator shows the actual rpm of the motor connected to the brushless speed controller.



Note

For a correct speed specification, the correct number of poles of the motor connected must first be set in the setting menu of the controller.

Current and consumption display

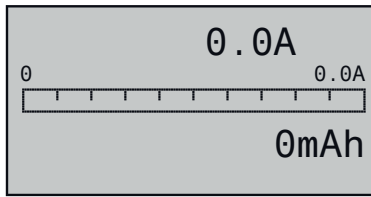

This display visualizes the currently flowing current; the peak current that has occurred during the current switch-on period, as well as the capacity consumed during the same period of the battery connected to the brushless controller.

Tension, current, RPM and temperature display

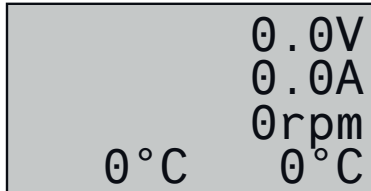

This display visualizes the current voltage of the power supply of the drive motor, the current flowing through the controller, the speed of the drive motor, the operating temperature of the brushless controller, and the temperature of a telemetry-capable drive motor.

Firmware update

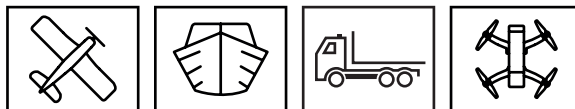

Firmware updates of the transmitter are carried out via the back micro USB port and the setting "PC COM Port" in the transmitter using a laptop or PC with Windows 7 ... 10.

The required programs and files are enclosed in a software pack and can be found for the corresponding product at www.graupner.de.

Download this software package from the Internet, and unpack it on your Windows PC or laptop.

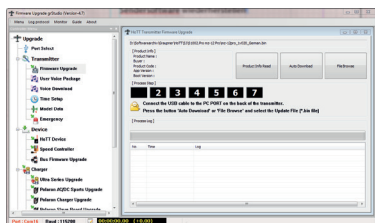

The update is carried out via the "Firmware Upgrade" program section of the program "Firmware_Upgrade_gr_Studio". Please follow the notes of the software. The further procedure is also described in detail in the manual contained in the data package. You can also singularly download these from the download page of the product at www.graupner.de.



Notes

- Please note that compatible firmware is required for reliable communication between the HoTT components. The programs and files that are required for updates are therefore combined into a single pack that is currently named "HoTT_Software_V4.zip".
- Only operate your transmitter using the current software version. The current firmware version can be found on the Internet at www.graupner.de.

Transmitter software update

Perform update step by step

1. *Before each update check the transmitter battery charge status.*
2. *Connect the back micro USB port of the switched off transmitter through the included USB cable to a PC.*
 - *Do not disconnect the link to the computer during an update! Make sure that the link between the transmitter and computer is operational.*
3. *Switch the transmitter on, select in "PC COM Port" in the display and push the ENT key.*
4. *Select the correct COM port in the program part "Port select" of the "Firmware_Upgrade_gr_Studio".*
5. *Launch the "Firmware_Upgrade_gr_Studio" and store for safety reasons all the occupied model memories through the program part "Model Data" to be able to restore them.*
6. *Launch the "Firmware Upgrade" program section of the program "Firmware_Upgrade_gr_Studio".*

7. *Select "Load automatically" or "Open file".*
8. *Select the "mz-12_...bin" file.*
The data transfer to the transmitter begins.
9. *The end of the data transfer will be indicated by the update program. The transmitter indicates the end of the transfer through the power on melody.*
10. *Switch off the transmitter and interrupt the USB connection to the PC.*
11. *After each update, check if the model functions are correct.*

Restoring the transmitter software

If a firmware update for the transmitter is unsuccessful or the transmitter program freezes and the transmitter cannot be turned off using the "POWER" switch, then remove the transmitter's battery after setting the switch to "POWER = OFF" position, or pull the plug from the transmitter battery. While making sure that the POWER switch is in the "OFF" position, wait a few seconds and then reconnect the disconnected battery.

In this case as well, download a current software package, as described at the beginning of this section, from the Internet and unzip it in your computer or, if you have already done this, start the "Firmware_Update_gr_Studio" and follow the information in the section "Restoration" in the instructions provided in the software package.



SIMPLIFIED DECLARATION OF CONFORMITY

Graupner/SJ hereby declares that the **S1002.PRO mz-12 Pro HoTT** complies with the Directive 2014/53/EU.

The full text of the EU Declaration of Conformity is available at the following Internet address: **www.graupner.de**

Notes on environmental protection

If this symbol is on the product, instructions for use or packaging, it indicates that the product may not be disposed with normal household waste once it has reached the end of its service life. It must be turned over to a recycling collection point for electric and electronic apparatus.

Individual markings indicate which materials can be recycled. You make an important contribution to protection of the environment by utilizing facilities for reuse, material recycling or other means of exploiting obsolete equipment.

Batteries must be removed from the unit and disposed of separately at an appropriate collection point. Please inquire if necessary from the local authority for the appropriate disposal site.

Care and maintenance



The product does not need any maintenance. Always protect it against dust, dirt and moisture.

Clean the product only with a dry cloth (do not use detergent!) lightly rub.

Warranty certificate

Graupner/SJ GmbH, Henriettenstrasse 96, 73230 Kirchheim/Teck grants from the date of purchase of this product for a period of 24 months. The warranty applies only to the material or operational defects already existing when you purchased the item. Damage due to misuse, wear, overloading, incorrect accessories or improper handling are excluded from the guarantee. The legal rights and claims are not affected by this guarantee. Please check exactly defects before a claim or send the product, because we have to ask you to pay shipping costs if the item is free from defects.

These operating instruction are exclusively for information purposes and are subject to change without prior notification. The current version can be found on the Internet at **www.graupner.de** on the relevant product page. In addition, the company ***Graupner/SJ*** has no responsibility or liability for any errors or inaccuracies that may appear in construction or operation manuals.

Not liable for printing errors.

